

A WORLDWIDE ONE-NAME STUDY:

THE *SHILVOCK* FAMILY

AND THEIR DESCENDANTS

(The main branch originally of the *SHELVOCK* name, including *SHELVOKE* and those with names reverting to *SHELVOCK* in the C19th), with main locations centred on the Halesowen area of England and their known links to other parts of the UK, Australia, New Zealand, US & Canada)

Compiled by Mark A. S. Grace
With thanks to many contributions from other researchers

Note on formatting: If view is corrupted, set margins to 0.5" and text to Courier 6pt.

SHILVOCK ONE NAME STUDY

CHART SV1: Descendants of Benjamin & Mary SHILVOCK of Late C18th St Martin's, Birmingham [BIBB/GRACE/PEZZANI/ROBERTS]

Probably from the Romsley CHART SV13A:

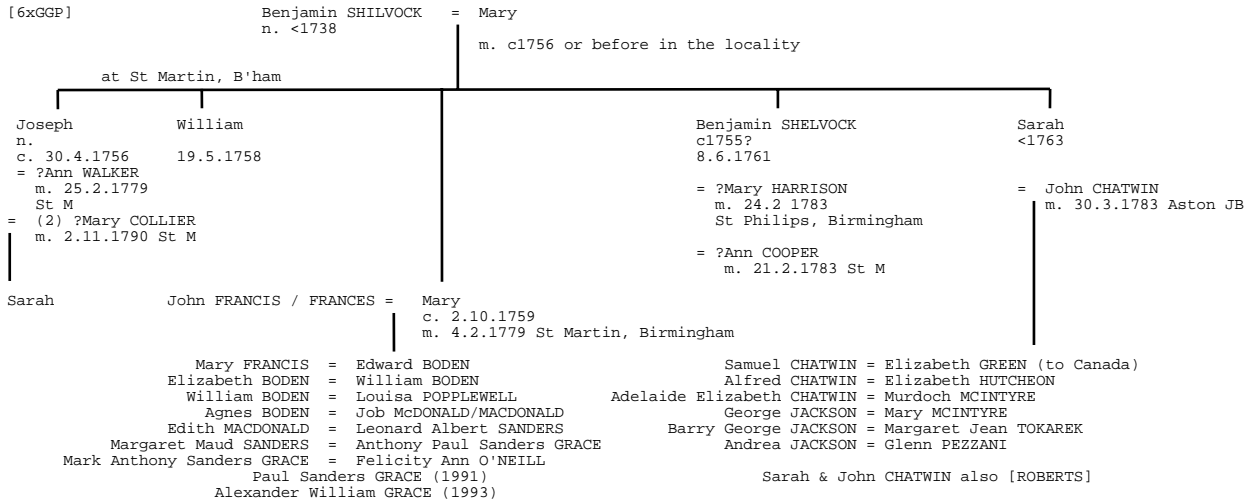

SV1 Notes

Status: Seeking C18th/C19th Descendants to connect to main clan in Halesowen, possibly from the Romsley family tree?
 Need to research all Benjamin marriages at St Philips & St Martin's, Birmingham to clarify partners.
 A Benjamin aged 74 (n. c1755) was buried at Halesowen on 15.3.1829

Current Benjamin "candidates":

Benjamin m. Elizabeth STEVENS or STEPHENS at Halesowen in 1746. This could be the first wife of the above, with Mary being the second marriage. No Benjamin birth/baptism, no Elizabeth death or Ann marriage dates found.

CHART SV2: Descendants of George SHILVOCK & Jane SMITH of C19th Clent/Bromsgrove, Worcs. [CARTWRIGHT]

42 Old Mill (Clent) in 1861:
 George SHILVOCK, 24, prob. Haulier or Nailer, WOR Hagley; Jane, 25 WOR Elmley Lovett; Jane, 8 (?), WAR Birmingham, Harriett, 1, WOR Clent (note daughter Jane's age may be more appropriately 3, not 8)

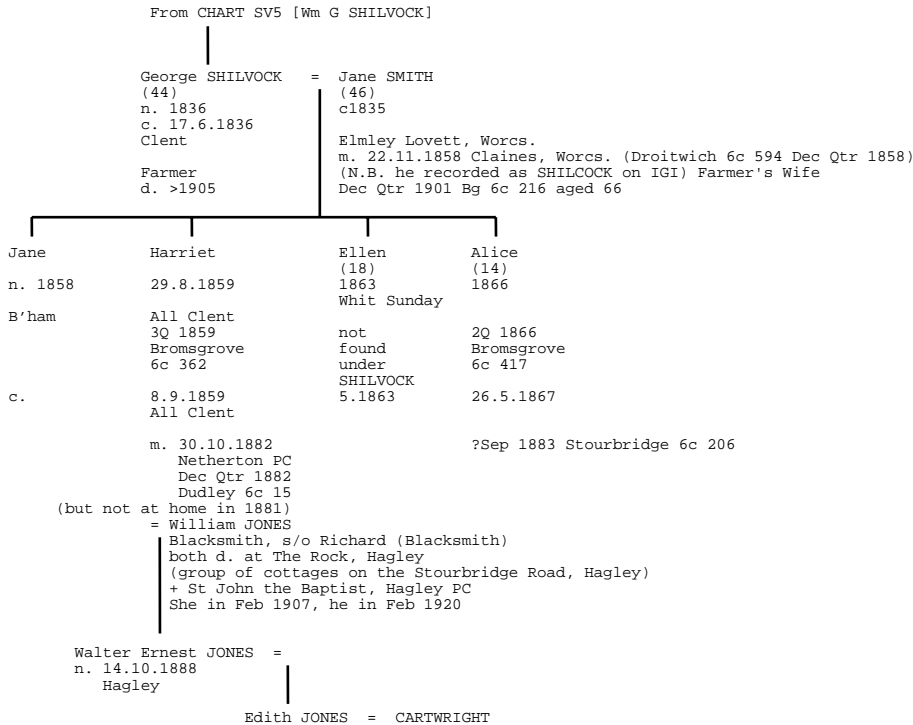

SV2 Notes

In 1871: at Holy Cross; George, Hay & Straw Dealer (34) with Jane (36), Harriet (11), Ellen (8), Alice (4)

George & Jane SHILVOCK at 125 Field Houses (next to Green Farm), Clent in 1881 (23 acres of land, employing a man & a boy) with Ellen (18) & Alice (14)
 Harriet (21) Domestic Kitchenmaid at h/o Frank EVERS, JP for Staffs and Worcs, at White Hall, Upper Swinford in 1881

SHILVOCK ONE NAME STUDY

CHART SV3A: Descendants of Isaac SHILVOCK & Maria of C18th & C19th Halesowen [COOTE / DIXON / TAYLOR]

Samuel possibly Samuel (1766) - Chart SV13D
 Note: CHART SV4A - Isaac s/o Joseph & Sarah was baptised one week later than this Isaac.
 Samuel & Phoebe are unknown. May be a short marriage to Samuel - the third wife after CHART SV12A

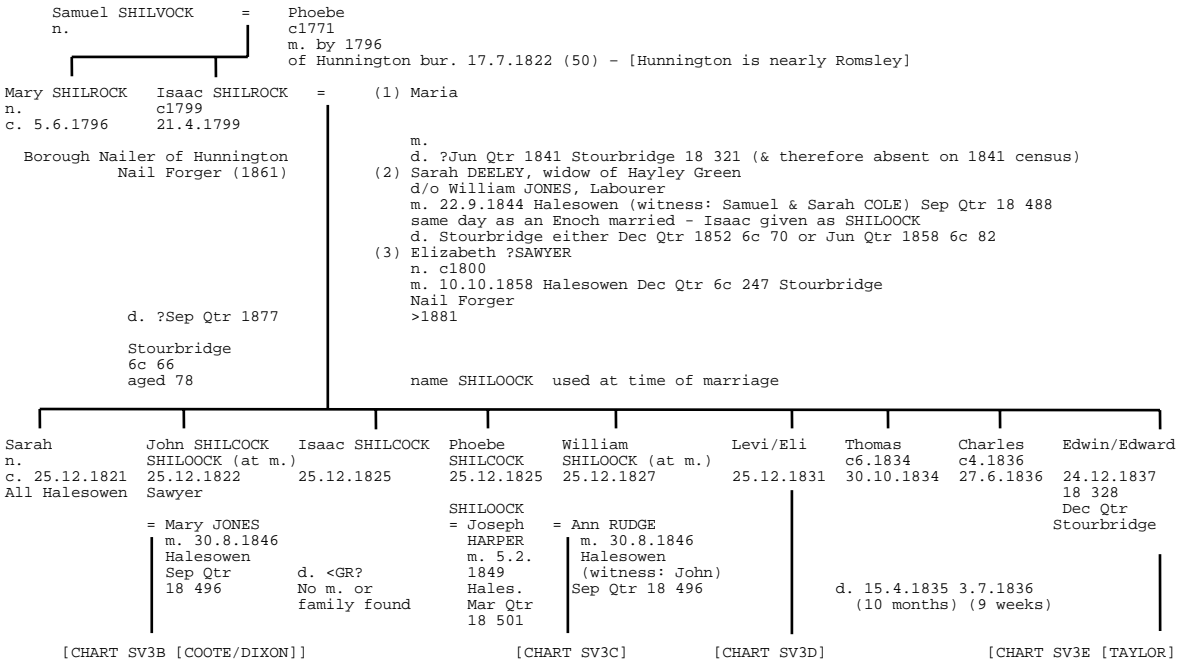

In 1841 Cornbow:

Isaac SHILVOCK	40	Nailor	Y
John	15		Y
Phebe	15		Y
William	12		Y
Eli	7		Y
Edwin	3		Y

at Little Cornbow in 1851 & 1861 with Eli (alone in 1851) n. c1831 (?Levi) & Edward n. c1838 (= Edwin). Both sons (of Maria?) were Labourers at the Ironworks

In 1861: 9 Little Cornbow

Isaac SHILVOCK	Head	M	61	Nail forger	all WOR Halesowen
Elizabeth	Wife	M	61	Nail forger	
Eli	son	U	30	Lab Iron work	
Edward	son	M	23	Lab Iron Work	

Elizabeth (81), widow, n. c1799 Cradley, Lodger, at h/o William & Fanny HARRIS on 1881 census; Great Cornbow, Whites Yard is probably Isaac's third wife. The HARRIS's may be related.

SHILVOCK ONE NAME STUDY

CHART SV3B: Descendants of John SHILVOCK & Mary JONES of Halesowen [COOTE/DIXON]

From CHART SV3A:

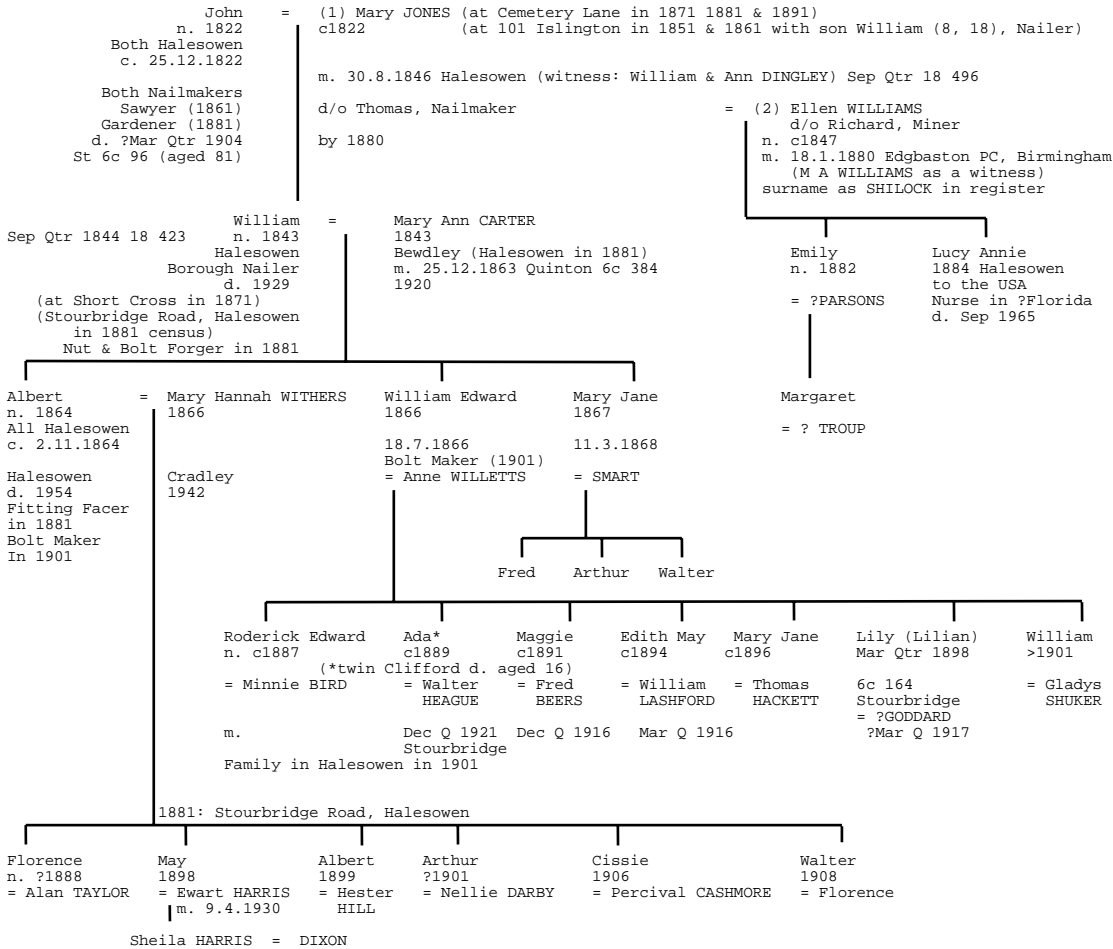

GenesReunited contacts:

- Roderick Edward/Edward Roderick [Dennis WOOD; denniswood (at) blueyonder.co.uk;
- Robin BIRD;
- Steve PACKHAM (Albert SHILVOCK);

Robin BIRD narrates:

Edward Roderick SHILVOCK was the second husband of my paternal GM Minnie Grace (nee Taylor then Bird). They married at Bearwood Baptist Church in Smethwick, West Midlands in July 1940 and lived at 40, Willow Avenue, Edgbaston. He died in March 1954 when I was only a year old - Of her 3 husbands, Frank BIRD, Edward SHILVOCK and Albert SIMCOIX, Edward was the one that my GM most loved and after the death of her 3rd husband Albert she changed her name by deed poll back to SHILVOCK.
Edward SHILVOCK was buried in Quinton Cemetery in a grave with a Black Headstone. In April 1989 following her own death Minnie Grace TAYLOR/BIRD/SHILVOCK/SIMCOX (October 1890 - April 1989) but was always known as "Minnie SHILVOCK" was buried in the same grave. He was an engineer of some kind (boat builder?) and that he did produce some very good wrought iron work for members of the family.

SHILVOCK ONE NAME STUDY

CHART SV3C: Descendants of William SHILVOCK & Ann RUDGE of Halesowen [COOTE/DIXON]

From CHART SV3A:

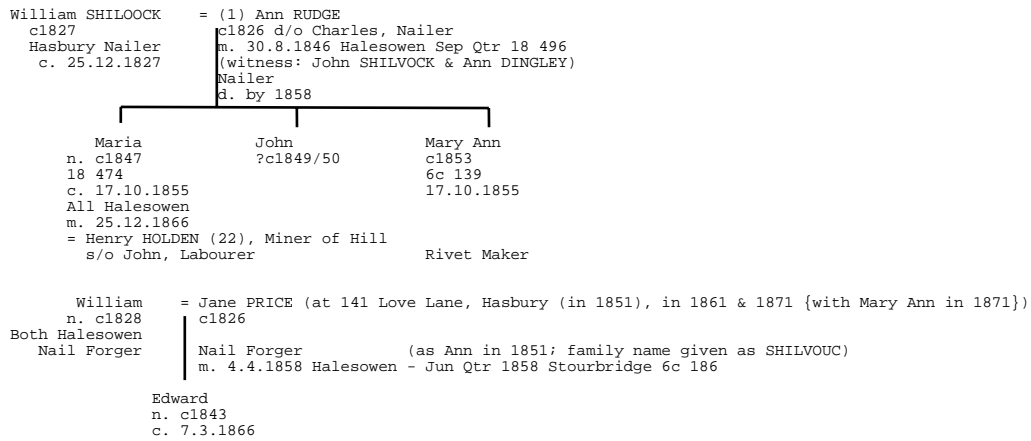

In 1881 in Hill St., Hasbury, William is home (53 n. c1828) with Mary Ann (26), both n. Halesowen. William, now a Grocer, is still given married, but no wife on census index. Son John in 1851 is too old for first marriage date (possibly a '1' instead of '7?').

Sheila's uncle spoke of a Henry & Maria HOLDEN who visited.

5, Love Lane, Hasbury in 1861

William SHILVOCK	Head	M	33	Nail forger	All WOR Halesowen
Jane	Wife	M	35	Nail forger	
Maria	Dau		13	Nail Forger	
Mary Ann	Dau		7		

William, a Grocer, still in Hasbury in 1901

CHART SV3D: Descendants of Eli SHILVOCK & Hannah of Halesowen [COOTE/DIXON]

From CHART SV3A:

At Spring Hill, Hasbury in 1881 - Eli, Hannah & Alice all given as nailers

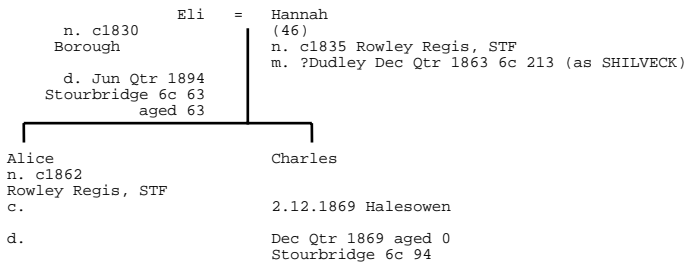

Eli given as 45 on 1881 census.

SHILVOCK ONE NAME STUDY

CHART SV3E: Descendants of Edwin/Edward SHILVOCK & Amelia of Halesowen [COOTE/DIXON/TAYLOR]

From CHART SV3A:

(Edward at Isaac's house on census day 1861 [DIXON])
 (at Short Cross in 1871 with children Maria, Hannah & David)
 (at Love Lane, Hasbury in 1881 with children Hannah, David, Alice & Emily)

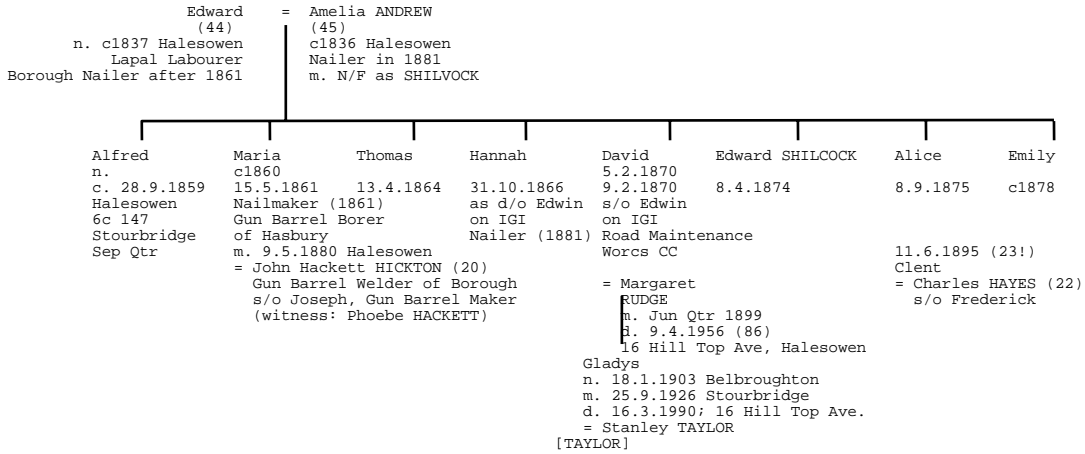

SV3 Notes

- Halesowen Clan of Nailmakers - Primitive Methodists

- 1861 census at Lapal, 50:

Mary ANDREW	Head	U	53	Nailer	WOR Halesowen
Amelia SHILVOCK	Dau	M	24	Nailer	WOR Halesowen
(Many other ANDREWS children)					

- 1881: Cemetery Lane John (50) and Ellen (34). If John born c1822 then would be 60 rather than 50. Mistake on census suspected since it seems correct for 1871.

- William n. 1843 possibly born before marriage. Birth date does not quite fit. When he married Mary Ann CARTER, may be an age error.

SHILVOCK ONE NAME STUDY

CHART SV4A: Descendants of Joseph SHILVOCK & Sarah of C18th - C20th Halesowen [BARTHOLOMEW / ?COOTE / ?DIXON / WYTHES]

Joseph origins uncertain, but could be the Joseph s/o Benjamin & Sarah on SV1?
 Also possibly born in 1766, died aged 83 and was buried on 27 Dec 1849 in St John the Baptist churchyard, Halesowen, probably the son of Daniel and Sarah on chart SV13A.

Joseph = Sarah (perhaps OWEN?)

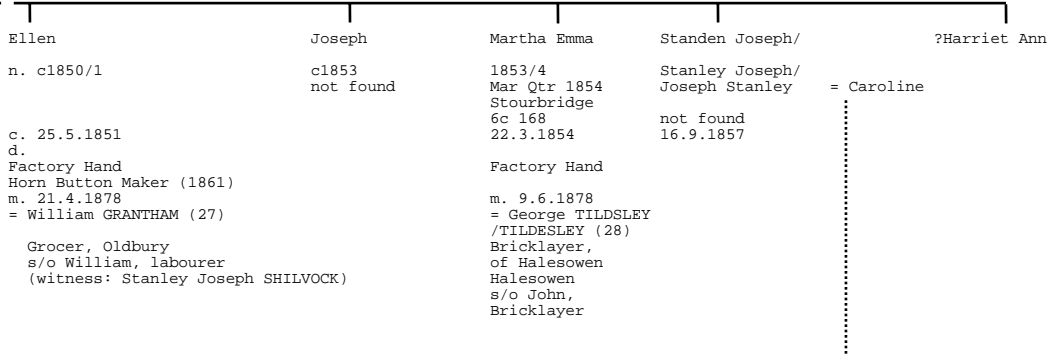
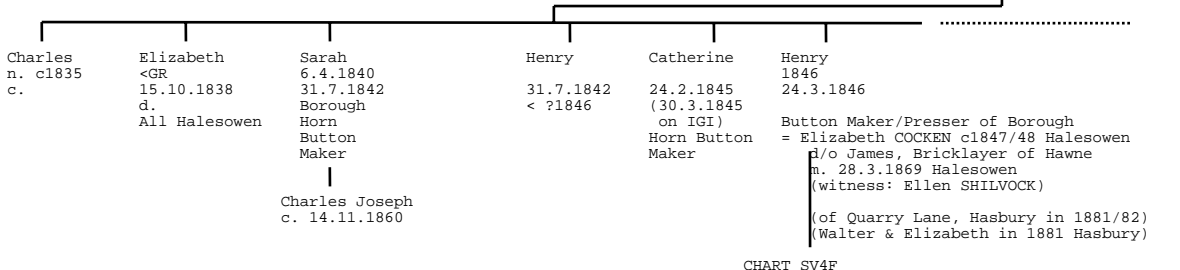
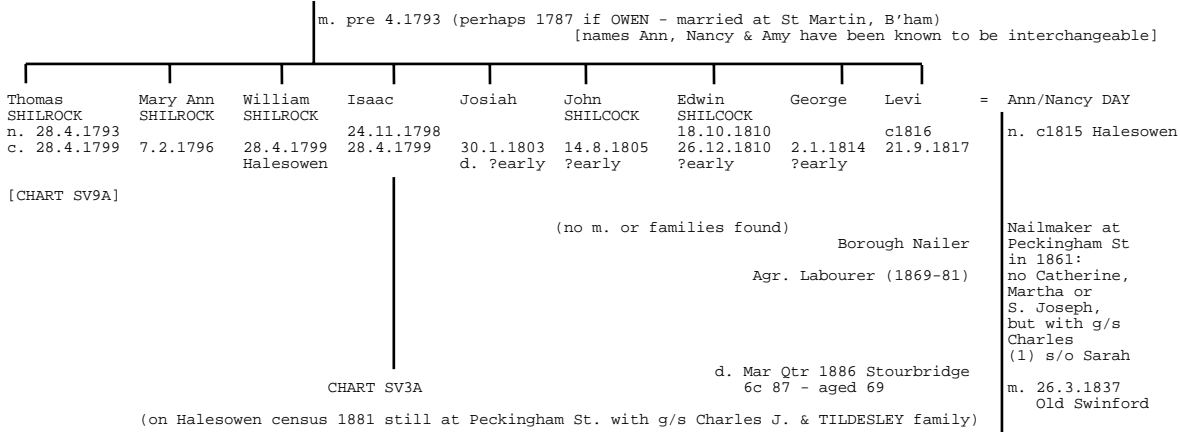

continued on next page

SHILVOCK ONE NAME STUDY

continued from previous page

Joseph S./ Stanley J. = Caroline/Catherine HEMMINGS (at Blackberry Lane in 1890-3)
 Fitter n. c1859 Rowley (details for Catherine in 1881)
 d. 1925 m. Mar Qtr 1880 Dudley 6c 146 (at Blackheath)

Alice Maud n. c12.1879 All c. 7.4.1890 Halesowen m. ?Dec Q 1917 = ?WATTS	Stanley Joseph c1882	Thomas Levi c1882	Ruth Gertrude 1884	Frederick William c1885	Ethel Mary c1890	Leonard Cavendish	Beatrice ? 28.9.1893
	Lab. at Tube Works (1901)	Painter a Carriage Works (1901) [CHART SV4E]		Carpenter for Bricklayer (1901)			

[recorded as Standen Joseph s/o Levi & Ann (likely mistranscription)]
 (in 1881 census there is a Joseph S. & Catherine at Peckingham St., Halesowen, with daughter Maude 4 months - this couple! Joseph is Overseer at Button Factory)
 Family at Hasbury in 1901 with Stanley, Thomas, Frederick, Emily, Ethel, Dora, Rose & Lillie.

Other named children by descendants:

Florence n. c1892 d.	Emily c1889	Dorothy May 20.2.1894 m. Sep Q 1913 Stourbridge = PARTRIDGE	Dora Carrie 24.10.1895 Dec Q 1916 = HALL	Rose Adelaide 18.8.1897 ?1985	Lily Louise 22.3.1900
----------------------------	----------------	---	---	-------------------------------------	--------------------------

1841 Halesowen:

Levi SHILVOCK	20	Nailer	Y
Ann	20		Y
Charles	6		Y
Elizabeth	3		Y
Sarah	1		Y

1851: in Hagley Street, Halesowen

Levi	34	Nailer	All n. Halesowen
Ann	35	Nailer	
Sarah	11	Horn Button Maker	
Henry	4		

1861: 68 Peckingham St

Levi SHILVOCK	Head	M	44	Nail maker	All born Halesowen, Worcs.
Ann	Wife	M	45	Nail maker	
Sarah	Dau	U	21	Horn Button Maker (HBM)	
Henry	Son	U	14	HBM	
Ellen	Dau		10	HBM	
Joseph	Son		7	Scholar	
Charles	GSon		1		
Elizabeth DAY	M in Law	W	70	Pauper formerly Nailer - ?Matriarch of the DAY sub-clan?	

Descendant: Brenda BARTHOLOMEW, Old School House, 45 Lydes Road, Barnards Green, Gt. Malvern, Worcs., WR14 2BV (01684 572260)

Maternal grandmother was the 7th of 13 children of Joseph & Caroline (has photos of the couple). They lived in Wall Well, Halesowen and she still have an Aunt there.

Joseph was a master musician and played the organ and piano in Halesowen, Romsley and Worcester Cathedral. He worked at the button factory. It was said that the SHILVOCKS came from Eastern Europe and were descendants of red-haired Jewish gypsies. Another has said that they set up a bank in Halesowen.
 Her Great Aunt Adelaide was matron at a Mental Hospital in Birmingham, and lived in Norton, Stourbridge until she died.

Blackcountryman Index (Black Country Society) - Article/Author/Volume/Issue/Notes/Names

- A History of the Button Trade in Halesowen (Part 2) / GF Grove / 17 / 2 / industry / John Jones, Daniel Parsons, James and John Grove, George and Mary Parkes, Edwin Shuker, Josiah and Thomas Coley, Maria Florence, Elizabeth and Louisa Adams, Thomas SHILVOCK, James Cockin, Joseph Hobday, Ronald Symes. (Which Thomas is this?)

SHILVOCK ONE NAME STUDY

CHART SV4B: Descendants of William SHILVOCK & Ann of C19th Halesowen [GARMAN / MILES / TILLEY]

From CHART SV12B:

William SHILCOCK/SHILOOCK/SHILVOCK was a Nailer at Lapal, Halesowen for baptisms of children 1824-29
 William SHILCOCK was a Nailer at Hasbury, Halesowen for baptisms after 1830.
 William believed to have originated from earlier SHILVOCK clan in the Romsley registers. RSK = Romsley St Kenelms

William may be s/o Joseph & Sarah, and the widowed lodger in Islington (aged 73) in 1871:
 In 1851 at Hagley Road, Halesowen there is a William (52 n. c1799 Halesowen), Grocer, with sons Joseph (22 n. c1829 Halesowen), Nailer, and Thomas (14, n. c1836 Halesowen), Scholar, daughter Fanny (11, n. c1840 Halesowen). William is in Worcs. Trade Directories as a Shopkeeper.

1841 Hasbury:

William SHILVOCK	40	Nailer	Y
Ann SHILVOCK	40		Y
William SHILVOCK	15		Y
Mary SHILVOCK	15		Y
Joseph SHILVOCK	10		Y
Thomas SHILVOCK	9		Y
Thomas SHILVOCK	4		Y
Fanny SHILVOCK	11 months		Y
Rebecca SHILVOCK	60		Y

Note: Rebecca is a much older unmarried sister on Chart SV12A

William SHILCOCK/SHILOOCK/SHILVOCK = Ann RICHARDS
 n. c1799 Halesowen
 Lapal Nailer (1827-44) m. 31.7.1823 Harborne, STS
 Grocer in 1851? d. Mar Qtr 1845 Stourbridge 18 403

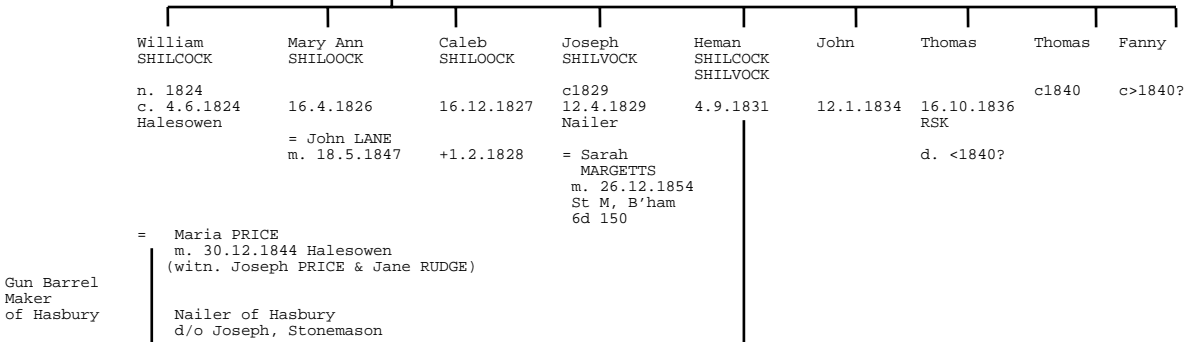

CHART SV6 [GARMAN]

CHART SV4C [MILES]

Jennie is the daughter of Joseph SHILVOCK (son of William SHILVOCK and Ann Richards SV4B) and his wife Sarah MARGETTS. Jennie was born in Canada (her father may have been selling chains from Cradley Heath to the Canadian logging companies) but returned to the UK and is shown as the head of the household in the 1901 census at 32 Sampson Road, Bordesley, Aston with her father Joseph (72) and Sarah her mother (71).

SHILVOCK ONE NAME STUDY

CHART SV4C1: Descendants of Heman SHILVOCK & Martha SOLEY of Halesowen & West Bromwich - The First Marriage [MILES / TILLEY]

From CHART SV4B:

Heman/Herman/Homan SHILVOCK = (1) Martha SOLEY
 n. c1831 Halesowen of Cakemore Gun Barrel Borer Baker in 1881
 d. 8.5.1913 (82)
 [buried Lodge Hill Cemetery, Bristol Road, with Sarah Will at June 1913 (p.349)]

n. c1825 Hagley (1861 census) of Cakemore
 m. 24.2.1850, Christ Church, Quinton Kings Norton RD, d/o Richard, Labourer
 witness: William SHILVOCK
 d. Dec Qtr 1866 W Bromwich 6b 403 (aged 45) or Dec Qtr 1865 Stourbridge 6c 89 if death not found, may have "absconded" with another man and may have taken his name [MILES]

Family in residence 1861 at Franchise Street, Perry Barr, Handsworth St Mary

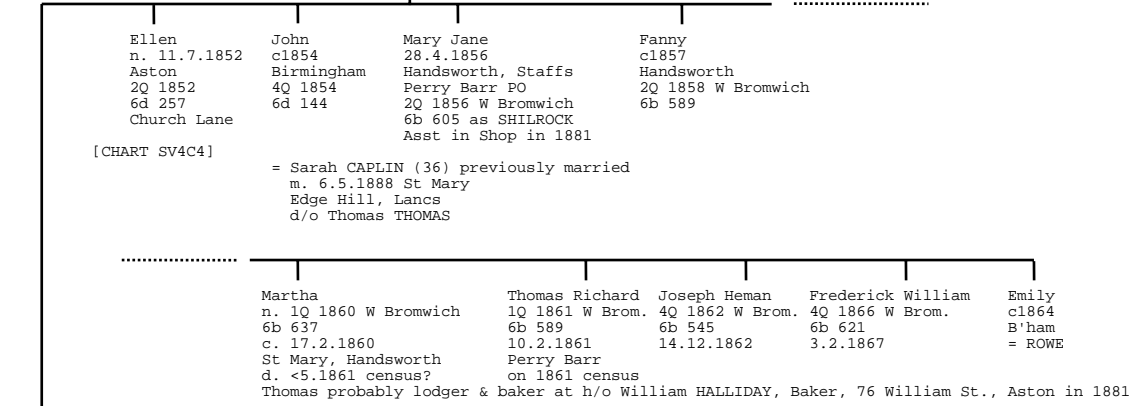

Samuel BRATT = (1) Charlotte EARP
 n. 1837, Aston
 d. 1909
 m. 1856, Aston 1919 (as widow) reg. by a daughter
 six children on 1871 Aston census [includes a Harriet & a Jane (n. 1871)]

= (2) Sarah Ann SHILVOCK
 n. 9.8.1850 Hasbury, nr. Halesowen [3Q 1850 Stourbridge 18 464] given as 42 (n. 1839) in 1881
 m. ?1871-74 but not found (** see note below)
 d. 21.12.1915 Sparkbrook, Birmingham (registered as the widow) at St Peter's Close, Wolverhampton 1891 as husband and wife Children all born Wolverhampton (census), 8 of 9 children plus Harriet & Jane

Sylvia BRATT (1886) = Thomas George MILES (1888)
 Barry MILES (1926)

Samuel BRATT was Parish Relieving Officer in Wolverhampton (relief was 2/6d per week), but Brass Founder of Ladywood Birmingham at time of Kate Amelia's birth. Wilfred Edgar BRATT, son of Samuel, was born West Bromwich 1874.

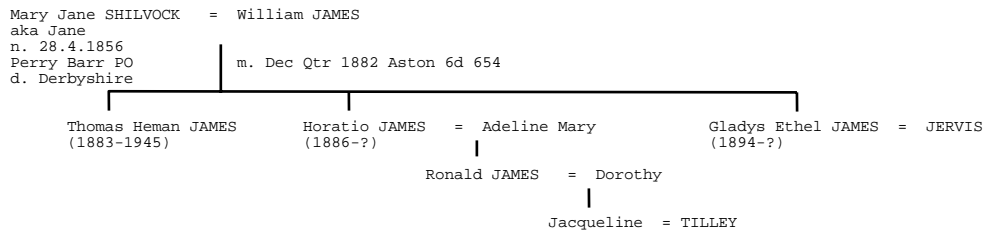

** Sarah Ann's marriage: 1863-1909 at St Catherine's searched. No Sarah Ann Marriages at all prior to 1890 as SHILVOCK. Probably other spelling variations such as SHELVOCK. First child born 1874. If no marriage, therefore 9 illegitimate children.

Gladys JERVIS, who worked at Queen Elizabeth Hospital, knew a Dr SHILVOCK and were believed to be related in some way.

1950's telephone catalogue contained a SHILVOCK firm of engineers in central Birmingham.

The 1851 census at Halesowen reveals how Heman & Martha started their married life at Grove Hill alias Wassell Cottages:

SOLEY, Richard	Head	M	62	Ag Lab	WOR, Churchill
Sarah	Wife	M	66	Laundress	WOR, Hagley
William	Son	U	36	Shoemaker journeyman	WOR, Hagley
Susanna	Dau		3		WOR, Hagley
SHILVOCK, Martha	Dau	M	23	Laundress	WOR, Hagley
ASHEAD, Mary	Dau	M	23	Laundress	WOR, Hagley
SHILVOCK, Herman	S in Law		20	Gun borer	WOR, Halesowen

The older generations of the JAMES family tell of an elopement in the past of a Patty SOLEY. Patty's father [a yeoman farmer], chased after the couple on horseback, but was too late to stop the marriage. Patty is a C19th nickname for Martha. Susanna either a child of Herman & Martha SHILVOCK or an earlier (illeg.) child of Martha or Mary (ASHTED) Will of Heman SHILVOCK, head of chart SV4C1, drawn up on 31st July 1911. He left a long list of furniture belonging to his late wife Sarah (See SV4C3) and 6 houses on Aston High Street to his youngest son Harry SHILVOCK, a printer living in one of the houses. He left the balance of his estate to his 6 surviving children from his first marriage:- John, Thomas Richard, Sarah Ann BRATT, Ellen GUEST, Mary Jane JAMES and Emily ROWE. He had lost contact with his oldest son John as he asked his executors to put his share in the bank and try and trace him. If not found within 5 years, then his share was to be divided amongst the other beneficiaries.

SHILVOCK ONE NAME STUDY

"Granny Guest" was remembered at her funeral in 1923, and uncle Harry the printer (actually his great uncle) was present. This means that Helen GUEST, Tim SHILVOCK's great grandmother, is almost certainly Ellen, the daughter of Heman. Ellen is her correct name.

CHART SV4C2: Descendants of Heman SHILVOCK & Mary Ann Harriett of Aston - The Second Marriage [MILES]

From CHART SV4C1:

Herman/Heman = (2) Mary Ann Harriett DAVIS (at Birmingham St Stephen)

n. c1839?
m. Mar Qtr 1869 Aston 6d 359
d. <1876
possibly Mary Ann (aged 35) 3Q 1874 Aston 6d 288

Agnes Mary
c. 26.3.1871
d. 2Q 1871 Aston 6d 210 (age 0)

CHART SV4C3: Descendants of Heman SHILVOCK & Sarah of Aston - The Third Marriage [MILES]

From CHART SV4C1:

Herman & Sarah at home in Aston in 1881 census with Mary J (24) [From first marriage], Emily (16) [hereto unknown daughter of first marriage] & Harry (3) at 75 High Street, Aston

Herman = (3) Sarah Elizabeth STANDEN (of Perry Barr)

(49) n. c1837/8 Halesowen (42 in 1881)
m. Mar Qtr 1876 Aston 6d 419
d. 9.4.1910 (72)
Both buried Lodge Hill Cemetery, Bristol Road

Harry*
n. Mar Qtr 1878
Aston

SV4C Notes

*Possible as Hy Grove SHILVOCK, printer, at 67 Hight Street, Aston in 1899

Birmingham Registrar confirms all three marriages relate to the same person i.e. Herman/Heman

At the marriage of Thomas LANE = Phoebe MORRIS at All Saints, West Bromwich in 1858, Heman was a witness. Life long friends suggested as they lived within three doors of each other in 1841 Hasbury and Thomas LANE's first son was named Heman. Heman's sister Mary Ann married Thomas's brother John 11 years earlier, linking the families.
Contact: Mrs Shirley HUGHES, 14 Criss Grove, Chalfont St Peter, Bucks, SL9 9HG for more on the LANE family.

Someone in the SHILVOCK family (possibly Heman, especially as he probably worked for B.S.A.) either invented or made a modification to a gun magazine

SHILVOCK ONE NAME STUDY

CHART SV4C4: Descendants of Ellen SHILVOCK

From CHART SV4C1:

Mentioned as "Helen" in family of Barry MILES:

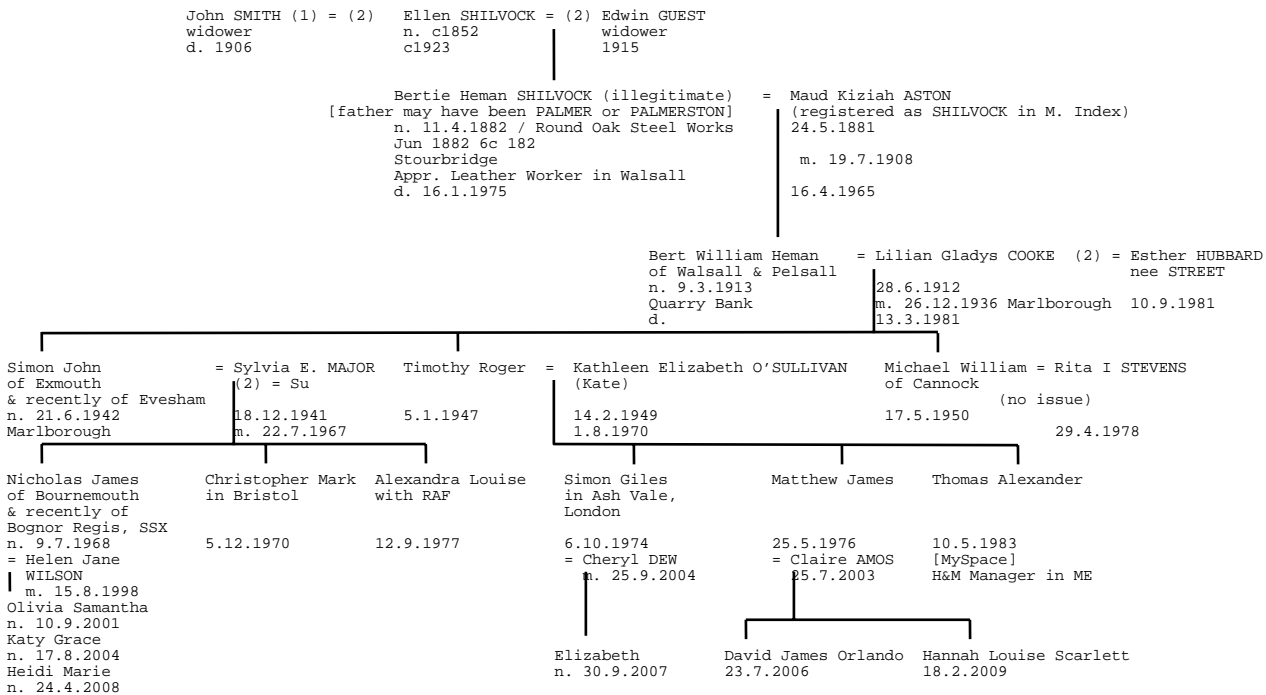

Notes

Family of T R SHILVOCK at Lower Binton Fm House, Binton, Stratford-upon-Avon, Warks CV37 9TQ
 Bert, as a child, lived on the Bristol Road, Edgbaston, then later moved to Bloxwich near Walsall.
 In 1930's lived in a house between Wolverley & Kinver designed by Tim's father.
 Tim's wife Kate as eisdad(at)csv.warwick.ac.uk
 Simon & Sue SHILVOCK. French Villa for Rent, Provence on Internet

2007: Simon E & Sylvia E at 14 HOUSMAN PARK, BROMSGROVE, B60 1AZ
 2007: Simon Giles & Cheryl at 8 HOMELEIGH CRESCENT, FRIMLEY ROAD, ASH VALE, ALDERSHOT, GU12 5PF

This assumed to refer to Bertie Heman, however while profession matches, date of death does not. 1975 death may be that on son, not the father.
 "Conveyance by Clara Matilda Warby of 728 Eccleshall Road, Sheffield, widow to Bert Heman SHILVOCK of 79 High Street, Bloxwich, Staffs., saddler of 207-213 Pedmore road, Woodside. Conveyance by SHILVOCK to Alice Beatrice Aston of Coppice Lane, Quarry Bank, spinster, 2nd May 1933. 31st Mar 1933."

Heman SHILVOCK's will names Ellen GUEST as one of his children. 1911 Census - Ellen GUEST (born Aston, 58) living in Spring Street, Hawne, Halesowen with husband Edwin GUEST (born Woodgate, Northfield, Worcs., 64).

Edwin GUEST, widower, married Ellen SMITH, widow on 2.4.1908 Stourbridge R.O. Ellen's father given as Heman SHILVOCK, Master Baker. Witnesses were Emily ROWE (Ellen's married sister) & Maude ASTON (Ellen's future daughter-in-law).

John SMITH, widower, married Ellen SHILVOCK, spinster, 8.6.1890 at Holy Trinity church, Amblecote near Stourbridge. Ellen's father given as Heman SHILVOCK, baker.

Bertie Heman SHILVOCK - His birth certificate has no father entered. His place of birth was given as "Round Oak Steel Works". He was probably born in one of the workers' houses within the curtilage of the steel works (now the site of the Merry Hill Shopping Centre).

Ellen's future husband, John SMITH, was married with 4 children and living in Rowley Regis at the time of Bertie's birth and is thought unlikely to be Bertie's father. Bertie thought his father's name was PALMER and a more likely candidate is George PALMER, a clay miner, born in Brierley Hill in 1859.

The censuses of 1891 and 1901 both show that Bertie was brought up by George and Phoebe SAVAGE in Quarry Bank.

Bert Heman SHILVOCK, bachelor, married Maud Keziah ASTON, spinster, at the Ebenezer Methodist New Connection Chapel, Stourbridge District on 19.7.1908. The marriage certificate states the couple "Previously went through a ceremony of marriage at this chapel on 4th July 1908, the Parties being then Bachelor and Spinster". The non-conformist chapel was new and may not have had the authority to marry people on the earlier date.

Based on property deeds held in the Dudley Archives: Bertie Heman SHILVOCK bought a row of houses (207-213 Pedmore Road, Woodside, Dudley near the Round Oak Steel Works) from Clara Matilda WARBY, a widow of 728 Eccleshall Road, Sheffield. He was living at 79 High Street, Bloxwich, Walsall, which was also his leather goods shop. He transferred the properties to his sister-in-law (his wife's younger sister) Alice Beatrice ASTON who lived in Coppice Lane, Quarry Bank. The properties were bought by Dudley Council as part of the Enterprise Zone when the steel works were demolished and now lie under the car park of the Merry Hill Shopping Centre.

Additional notes c/o Tim SHILVOCK (2009)

SHILVOCK ONE NAME STUDY

CHART SV4F: Descendants of Henry & Elizabeth SHILVOCK - DAY alias [WALTON]

From CHART SV4A:

Harry of the "DAYS" alias clan.

Harry & Elizabeth of 28 Quarry Lane, Hasbury in 1917. Noted on War Graves at the Somme for Ernest d. 13.4.1917 (26) WWI

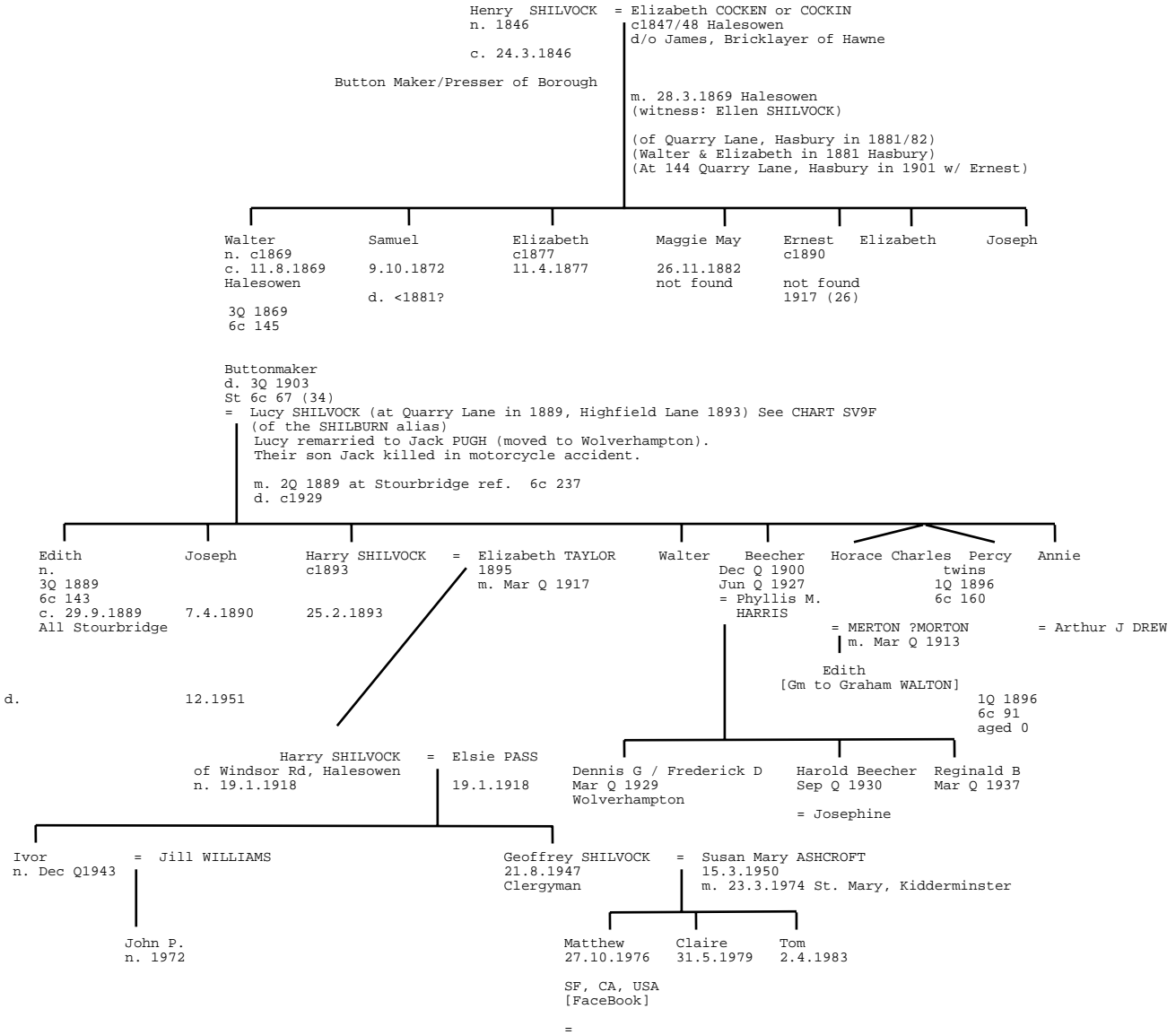

Note: Walter, Beecher & Annie moved to Wolverhampton with Lucy SHILVOCK nee SHILVOCK's second marriage.

E-Roll:
SHILVOCK, Ivor, Jill, John P. 90, Albert Road (Wall Well), Halesowen, West Midlands B63 4SL
Geoffrey & family at Wolverley Vicarage - Fax: 01562 851133

According to the London Sunday Times (Jan. 26, 1997) a survey of 200 members of the Anglican clergy found that some could only remember two of the Ten Commandments passed down from God to Moses. Only 34 percent could give all ten commandments. The London Sunday Times survey also showed two vicars did not believe in heaven, more than half believed there is life on other planets. Geoffrey SHILVOCK, from Wolverley, Worcestershire, who could not remember all of the commandments, questioned their prohibitive nature, saying, "The trouble is that they are very negative ... most people prefer a more positive approach."

Diamond days for couple: "Harry and Elsie SHILVOCK, of Windsor Road (Stourbridge), met and fell in love at St John the Baptist Church where they later tied the knot." Express & Star (no date)

2007: Harry & Elsie at 70 WINDSOR ROAD, HALESOWEN, B63 4BH
2007: possibly John P & Ms Sarah L WALLIS at 78 SHENSTONE AVENUE, STOURBRIDGE, DY8 3ET

GenesReunited contact: SHILVOCK = DREW [Kulli SARAN], Harold Beecher [Leslie John ELSMORE]

SHILVOCK ONE NAME STUDY

CHART SV5A1: Descendants of John SHILVOCK & Mary of Clent, Worcs. [CARTWRIGHT / Jill / William G / BRADLEY]

Possibly from CHART SV13B:

Note 1: Original data supplied by W. G. SHILVOCK [via DIXON] has been amended based on St Catherine's Indices & Jill SHILVOCKs research.

Note 2: The alias of SHILBURN appears alongside SHILVOCK in this family - earliest ref: John SHILBURN otherwise SHILVOCK bur. Feb 1761 Halesowen; possibly John's father or grandfather. Name adopted, from common law marriage, or some pet name?

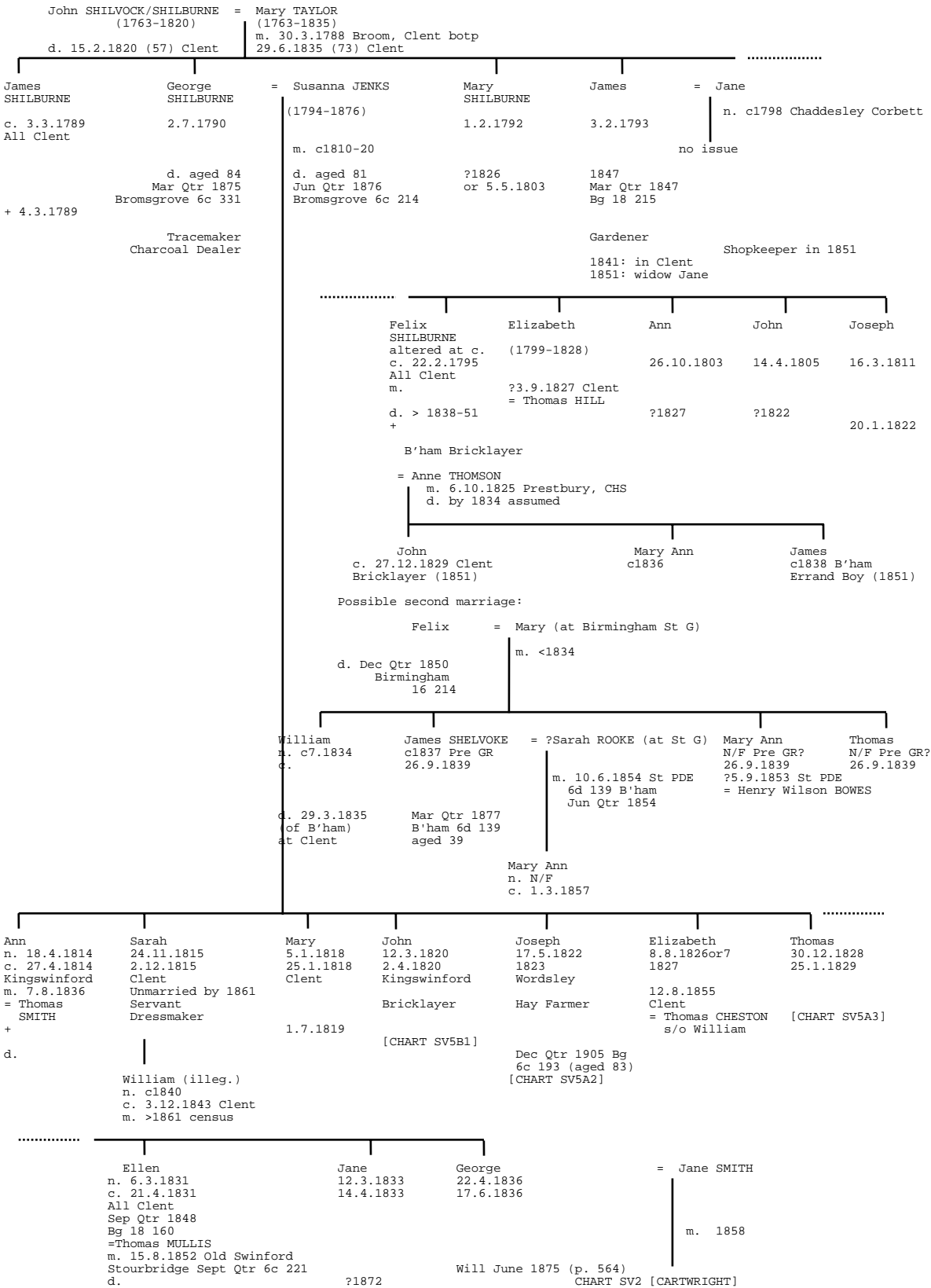

SHILVOCK ONE NAME STUDY

- SHILVOCKs were well known bellringers in Clent.

- 1841 Clent - Clent Hall:

SHILVOCK, George	50	Trace Maker
Susanna	45	
John	20	Bricklayer
Joseph	18	
Elizabeth	14	
Thomas	12	
Ellen	10	
Jane	8	
George	5	

(Sarah presumably living with another family)

- 1851 Clent census (index) contains Charles (75, n. c1776 Halesowen, probably d. Dec Qtr 1857), George (60, n. c1791 Clent, probably d. Mar Qtr 1875) [George above? who married Susannah?], and 22 other younger persons

011 Holy Cross, Clent, Bromsgrove 1851 census:

SHILVOCK, George	HD	M	60	Beer House Keeper	All WOR, Clent
Susanna	Wife		56		
Sarah	Dau	U	34		
Thomas	Son	U	22		
George	Son		14		
William	G/S		10	Scholar (s/o Sarah)	

The following 1861 entry is probably the above with Susannah being recorded as Hannah:

56 Holy Cross (next to the Butcher's Shop):

George SHILVOCK	HD	M	70	Charcoal Dealer	All WOR, Clent
Susannah/Hannah	Wife		66		
Sarah	Dau	U	45	Dressmaker	
William	G/Son	U	20	Servant	

Still at Holy Cross in 1871: George (80), Susanna (76) with Sarah WOODSIDE (15), Servant

Cheshire Strays in the 1851 Census of Warwickshire

SHELVOCK, John 1830 Mansfield, CHS (should be NTT) at 44 Cottage Lane, Birmingham
This is the widow Ann THOMSON who married Felix SHELVOCK 6.10.1825 at Prestbury, Cheshire.
Lots of apparent inaccuracies.

Ann SHELVOCK	Head	W	54	No occupation given or place of birth (n. c1798, m. by 1830)
John SHELVOCK	Son	U	21	Bricklayer (n. c1830) Mansfield-CHS
Mary Ann SHELVOCK	Dau	U	15	Birmingham (n. c1836 possibly m. Sep Q 1870 Wrexham as SHELICK)
James SHELVOCK	Son	U	13	Errand Boy (n. c1838) Birmingham

GenesReunited contact: Elizabeth SHILVOCK = Thomas HILL [Anne SHAW]

Also connected through Betsy SMITH = Joseph SHILVOCK [Chart SV10D1]

SHILVOCK ONE NAME STUDY

CHART SV5A2: Descendants of Joseph SHILVOCK of Clent - First Marriage to Eliza - Second Marriage to Mary [Wm G SHILVOCK / BRADLEY]

From CHART SV5A1:

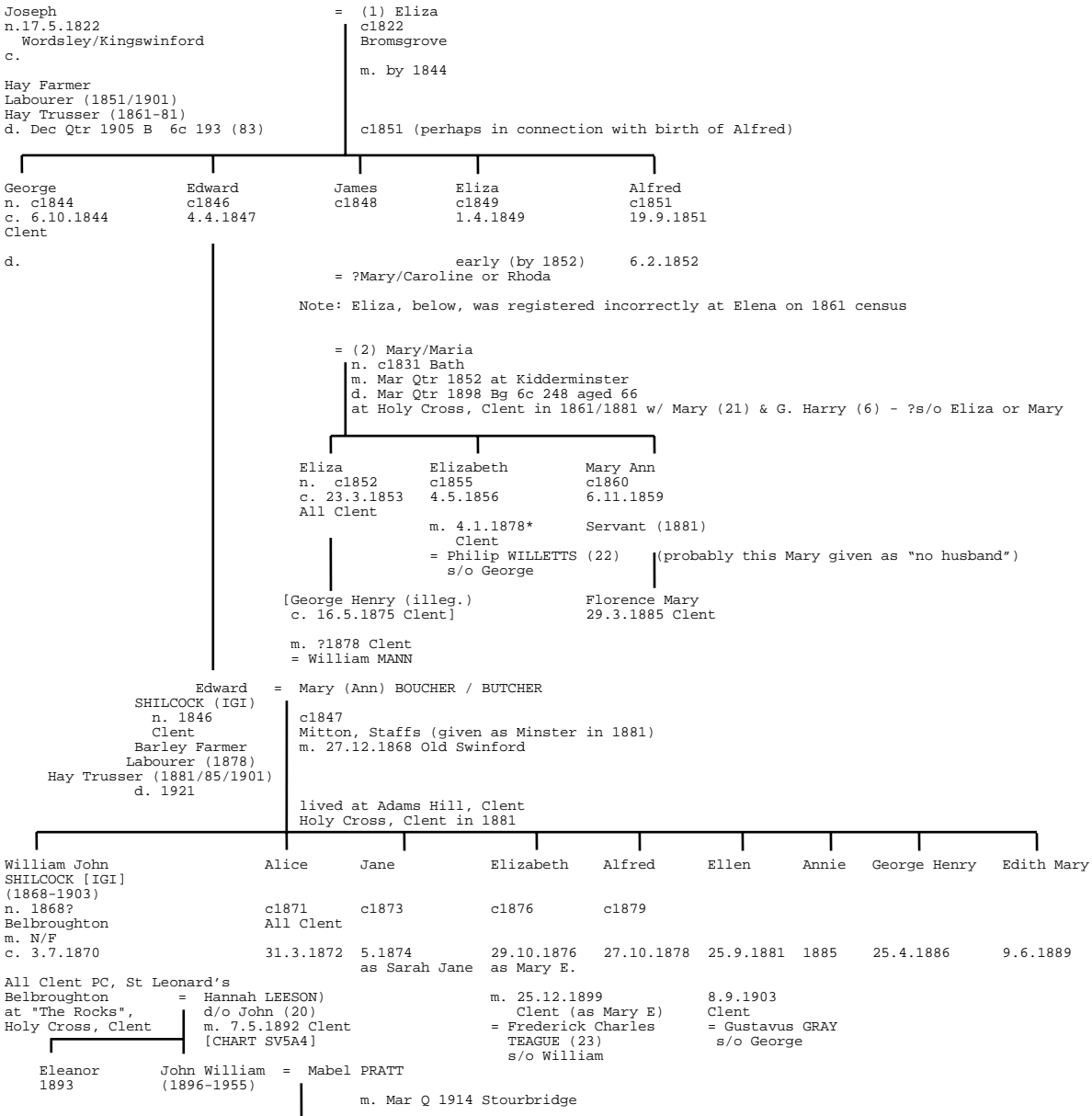

096 Old Mill, Clent, Bromsgrove 1851 census:

SHILVOCK, Joseph	HD	M	28	Labourer	STS Kingswinford
Eliza	Wife		28		WOR Bromsgrove
George	Son		6	Sch	WOR Clent
Edward	Son		4		WOR Clent
James	Son		2		WOR Clent

1861 for Joseph & Mary at 119 Holy Cross:

Joseph SHILVOCK	HD	M	38	Nail Binder	All WOR Clent
Mary	Wife		29		except SOM Bath
James	Son		12	Sch	
Elena	Dau		8	Sch	
Elizabeth	Dau		5		
Mary A.	Dau		1		

1871 at Holy Cross: Joseph (43) Hay Trusser, with Mary (41), Charwoman), James (22), Eliza (16/18), Elizabeth (15) & Mary Ann (11).
 1881 at Holy Cross: Joseph (58), Mary (50), Mary (21) Domestic Servant, G. Harry (grandson, 6)
 1901: Dudley - Alfred (22), Policeman with wife Elizabeth (25, of Dudley) & Mary (6 weeks)
 1901: William & Hannah with Eleanor & John in Clent.

* There is the baptism of Charlotte WILLETS 27.1.1878 St Leonard's PC, Clent d/o Elizabeth SHILVOCK (single woman). This is only three weeks after she married WILLETS. Probably an error on the part of the recorder. Her husband was not present.

SHILVOCK ONE NAME STUDY

GenesReuntied contact: Hannah SHILVOCK d/o Edward & Mary [Terrance BROOKS]

George HADLEY (n. Halesowen 12.7.1865 s/o Hannah TAYLOR (1829 Northfield) & William HADLEY (1827 Hasbury) m. Clent in August 1847), m. 1890 = Hannah SHILVOCK at Barrow in Furness. Location of marriage for both Halesowen born something of a surprise, even more so because in 1901 the couple were living back in Halesowen. Connection is through Hannah TAYLOR (sister of Terry's GGF).

SHILVOCK ONE NAME STUDY

CHART SV5A3: Descendants of Thomas SHILVOCK aka SHILCOCK & Maria SMITH of Clent, Worcs. [Wm G SHILVOCK]

From CHART SV5A1:

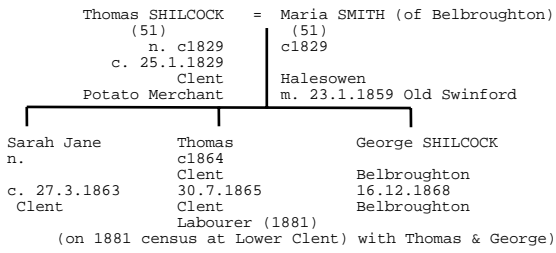

In 1871 at Clatterbatch with all 3 children. Sarah Jane as Jane.
 In 1901, Thomas still in Clent.

CHART SV5A4: Descendants of William SHILVOCK & Hannah LEESON of Clent, Worcs.

From CHART SV5A1:

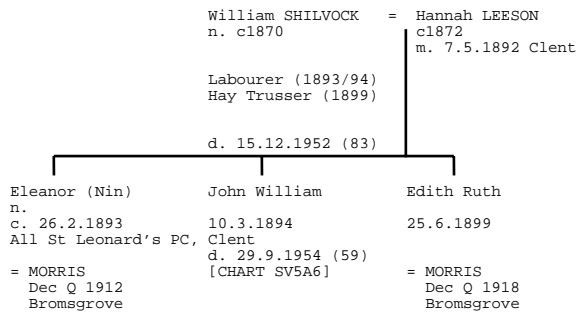

Notes:

William's gravestone G1 Red South Side
 John William's gravestone H2 Red South Side
 Nin & Ruth (both daughters married MORRIS brothers, farmers)

SHILVOCK ONE NAME STUDY

CHART SV5A5: Descendants of George SHILVOCK & Jean of Clent, Worcs., Rugby, WAR & Australia [WILLCOX]

Contact email: sarahwillcox(at)lifetime.net
 Roy F SHILVOCK & June Rose, 25 Wentworth Street, Taree, NSW 2430, Australia (02) 6552 6190
 Mark Richard at 33 Rifle Range Rd, Bligh Park 2756 - (02) 4572 0457
 James Leigh at 17 Ferguson Ave., Castle Hill, 2154 [68 Kurnell Rd Cronulla 2230 - (02) 9523 9707]
 From Australia Business Directory:
 ABN / Business Name / Name / Type / Location
 13 709 902 767 SHILVOCK, MR JAMES LEIGH: 2230 NSW; CONNECTIONS CONTRACTING (NSW 2230)

From CHART SV5A2: possibly the illegitimate s/o Eliza

Family on 1901 census in Hagley

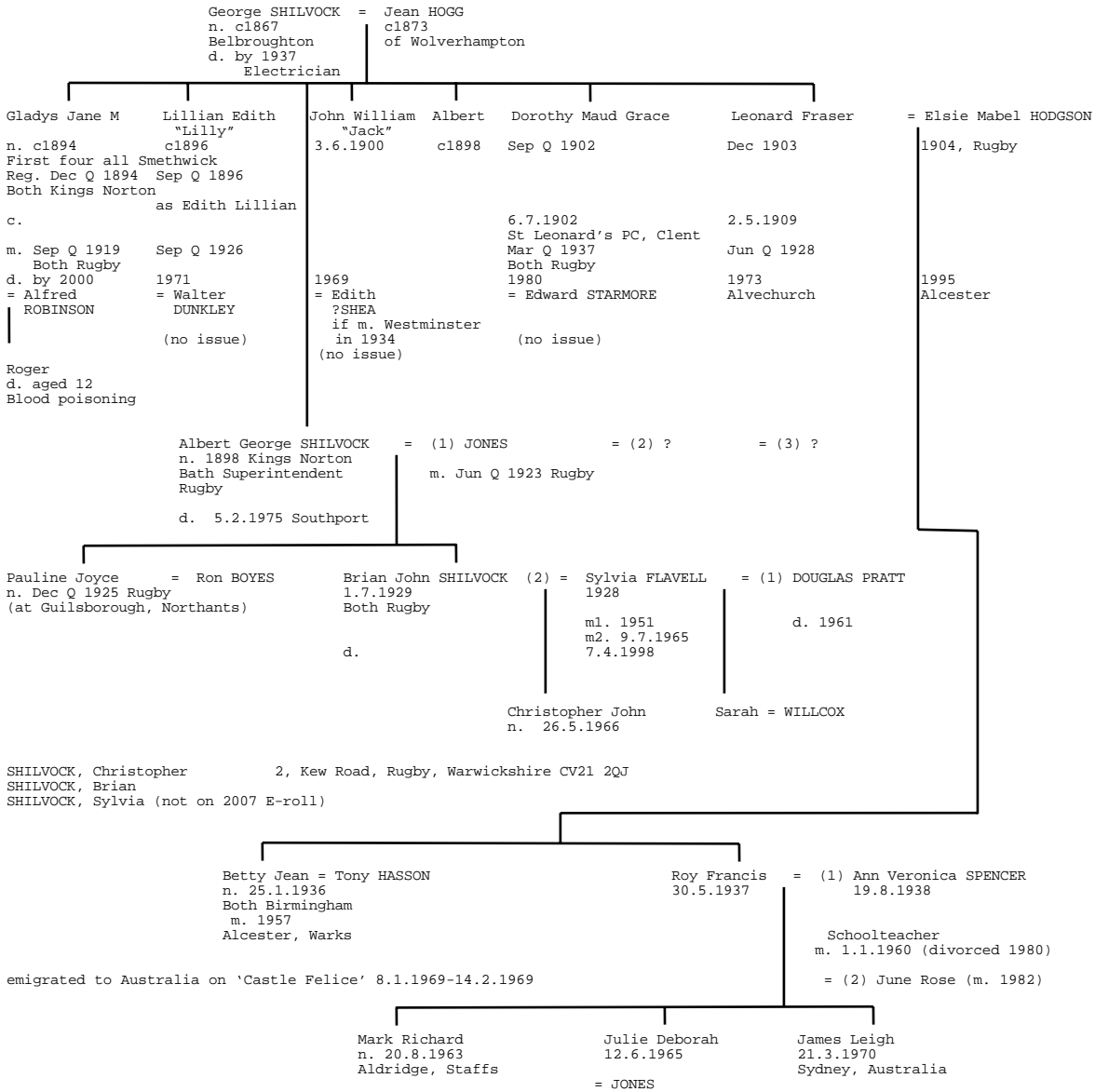

Notes

According to Australian sources Bert was married, then divorced, before remarrying and then "disappearing".

SHILVOCK ONE NAME STUDY

CHART SV5A6: Descendants of John William SHILVOCK & Mabel of Clent, Worcs. [William G. / BRADLEY / GenesReunited]

From CHART SV5A2:

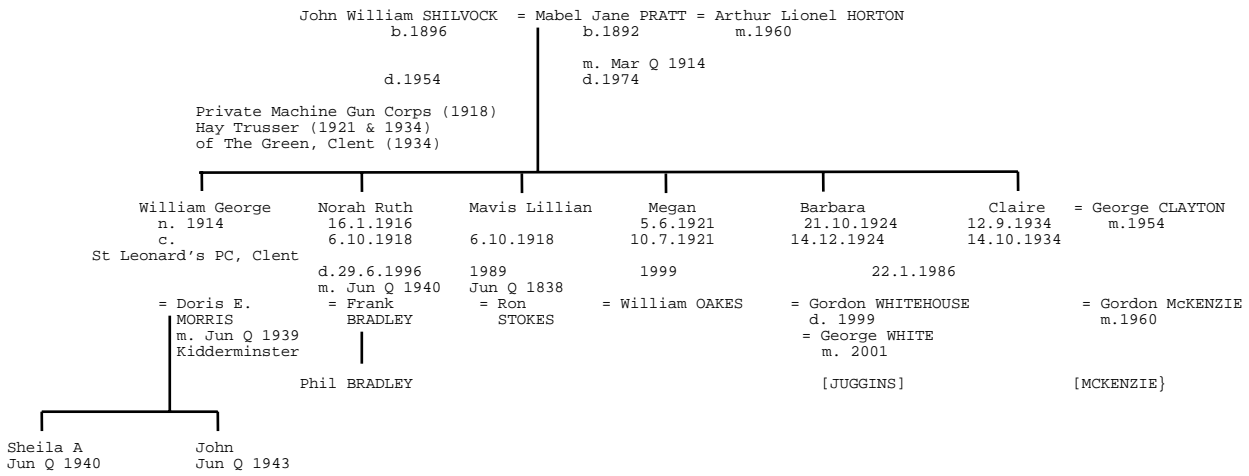

Phil BRADLEY [philbradley(at)themutual.net]
 2000: William George at 36, The Crescent, Hagley
 2000: Barbara at 27, the Heathlands, Stourport-on-Severn (Tel 01299 827616).

GenesReunited contact: Anne MCKENZIE [annemckenzie (at) btinternet.com], Linda JUGGINS

SHILVOCK ONE NAME STUDY

CHART SV5B1: Descendants of John SHILVOCK & Elizabeth of Clent, Worcs. [Jill / William G / BRADLEY]

From CHART SV5A1:

Family at Field Lane, Upper Swinford in 1881 (John & Elizabeth w/ Herbert & Jesse)

John (61) n. c1819 Clent c. 2.4.1820 Kingswinford Bricklayer d. Jun Qtr 1901 St 6c 95 aged 81	= Elizabeth ?ALLEN (at Dodderhill) (57) n. c1823 Stoke Prior Crowle, WOR m. 18.5.1841 Droitwich St Peter - ref. N/F
---	--

John E. n. c1845 [SV5C] c. Stoke Prior	Christiana c1848 27.11.1848 Dodderhill Doddinghill PR, of Shaw Lane n. Dec Qtr Droitwich 18 233 d. Mar 1870 aged 21 Bromsgrove 6c 303	Felix c1850 4.5.1851 Clent	Alfred & Ellen c1852 5.12.1852	Jane Marian c1854 2.9.1855	Camilla c1858 4.12.1859	Herbert c1861 30.9.1861 Clent Both Bricklayers Labourers in 1881	Jesse George (as Jepe George on census; short form of "double s") June Qtr 1864 Hagley / Bromsgrove 6c 409 [CHART SV33?]
--	--	---	---	---	-----------------------------------	--	---

015 Holy Cross, Clent, Bromsgrove 1851 census:
 SHILVOCK, Elizabeth HD Widow 27 Bricklayers wife All WOR, Stoke Prior
 John Son 5
 ChristianaDau 2
 Felix Son 5 months
 (N.B: this "widow" seems to an error, John must have been not at home on census day.)

1861 at 118 Holy Cross:
 John SHILVOCK HD M 41 BricklayerWOR Clent
 Elizabeth Wife M 37 WOR Crowle
 John E. Son 15 Railway Lab WOR Stoke Prior
 ChristianaDau 12 Sch WOR Dodderhill
 Felix Son 10 Sch WOR Clent
 Alfred Son 8 Sch WOR Clent
 Jane Dau 6 Sch WOR Clent
 Camilla Dau 2 WOR Clent
 Herbert Son 3 months WOR Clent

DODDERHILL

An extensive medieval parish, its s end, with the church, now part of Droitwich.

ST AUGUSTINE. A very interesting church, originally cruciform, on the site of the Roman fort overlooking Droitwich (q.v.), and possibly of a Saxon minster. What remains, outside and in, is surprising, its history much obscured by patching because of subsidence, by partial demolition after the Civil War, and by dubious c19 restoration. The mighty four-stage s tower, rebuilt on the site of the medieval s transept in 1708, dominates the exterior; the tooling betrays its date. The central tower was dismantled in the c17, when the nave also disappeared. Much of the material of the demolished tower must have been stored and reused; the two-light bell-openings are clearly late medieval, as is a tiny light for the stair-vice, high up, s side. The long e and w lancets may be c13 survivors of the s transept, their particularly deep splays perhaps the result of thickening the walls to carry the tower. N transept also medieval, partly rebuilt in brick from c. 1803, with tracery (Perp n, Dec w) renewed by *John Shilcock*, 1848. He filled the former arch to the nave with flowing tracery in 1850. The similar tracery in the ambitious Dec chancel may also be untrustworthy; it would be very progressive for 1322, the date

SHILVOCK ONE NAME STUDY

CHART SV5B2: Descendants of Felix SHILVOCK & Ann HILL of Clent, Worcs. [Jill]

From CHART SV5B1:

also with William HILL (SHILVOCK), 71 widower, Nailmaker of Oldswinford, wife's father; Henry HILL, wife's brother (29) In 1871 at same address with Henry HILL as Painter. Felix & Ann with 14 day old Mary A.

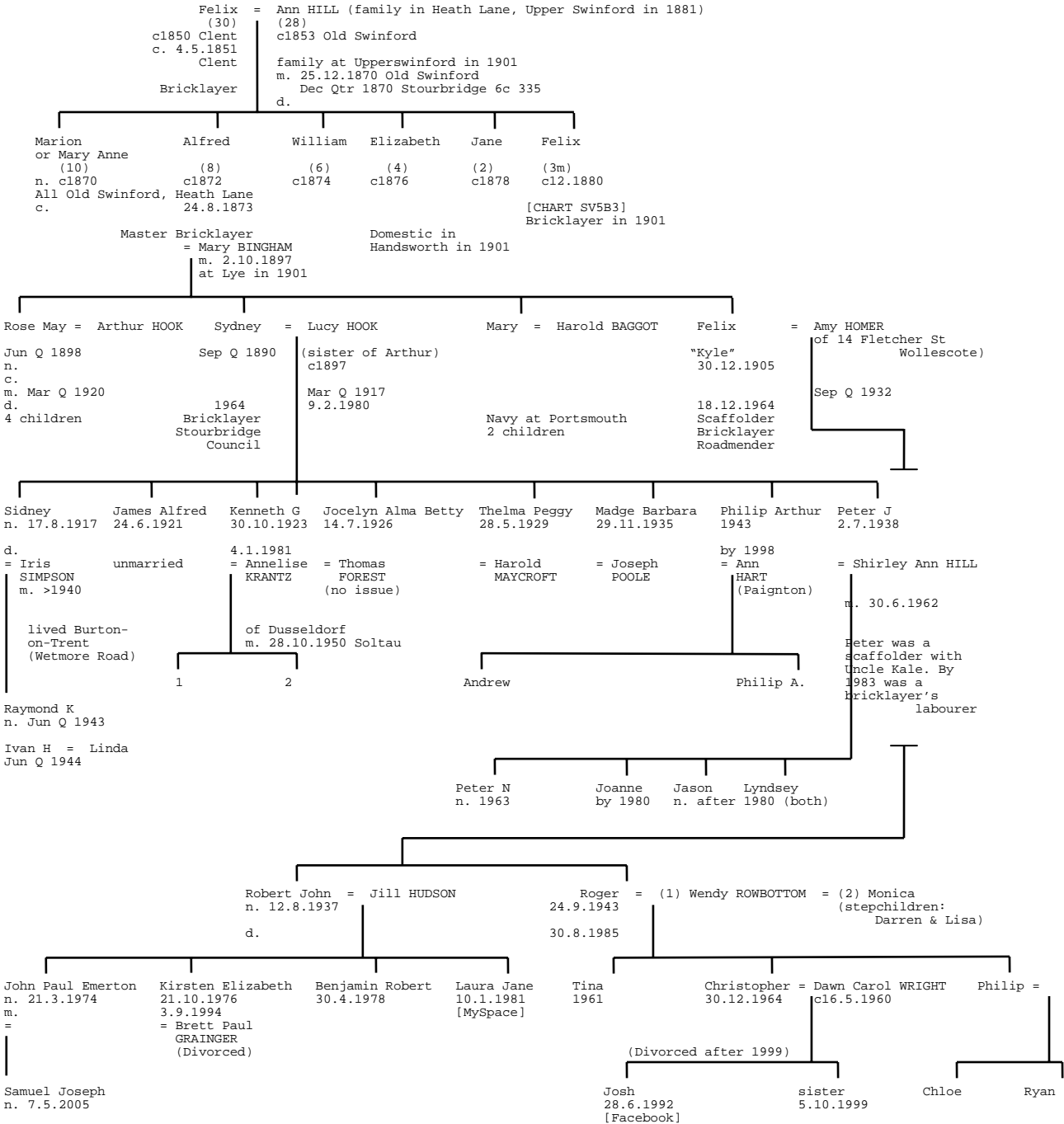

2007 address of the Derbyshire sub-clan: Not all relationships established.
 Miss Pamela & Roy K at 131 CHESTNUT AVENUE, MIDWAY, SWADLINCOTE, DE11 0EW
 Raymond K at 32 WOODVILLE ROAD, OVERSEAL, SWADLINCOTE, DE12 6JG
 Miss Clara at 21 WOODVILLE ROAD, OVERSEAL, SWADLINCOTE, DE12 6JG
 Pauline A at 175 WETMORE ROAD, BURTON-ON-TRENT, DE14 1QZ
 Mark & Tracey at 12 SEYMOUR AVENUE, BURTON-ON-TRENT, DE14 2AQ
 Ivan H & LINDA at 7 WINCHESTER DRIVE, BURTON-ON-TRENT, DE14 3AZ
 Christopher R & Janet with Martin P at GREAT NORTHERN, WETMORE ROAD, BURTON-ON-TRENT, DE14 1QS
 Ms Michelle J SHILVOCK and Adrian A SMITH at 23 HEATH ROAD, BURTON-ON-TRENT, DE15 9LG

Kenneth G - Golden Lion Inn Stourbridge: Licencee 1960-61

SHILVOCK ONE NAME STUDY

Notes:

SHILVOCK, Sidney 56, Wetmore Road, Burton-On-Trent, Staffordshire DE14 1QS (1998 Electoral Roll)
SHILVOCK, James Alfred 1 New Farm Road, Stourbridge (not on Roll)
SHILVOCK, Andrew 22, Underidge Drive, Paignton, Devon TQ3 3XP (Arthur assumed deceased by 1998)
SHILVOCK, Philip A.
SHILVOCK, Ann
SHILVOCK, Peter J. 38, New Farm Road, Stourbridge, West Midlands DY9 7PQ
SHILVOCK, Peter N.
SHILVOCK, Joanne
SHILVOCK, Shirley A.

Medical Note - there appears to be hereditary diabetes in this branch, supposedly from the HOOK family. Possibly Kenneth had diabetes, whereas Madge had both legs amputated as a result of this. Could have been recessive and from an earlier generation. (ref. one US enquiry).

SHILVOCK & HARRIS:

The Stourbridge plumbing firm of SHILVOCK & Harris was formed in 1970 by Roger SHILVOCK (above) & Jim HARRIS.

SHILVOCK ONE NAME STUDY

CHART SV5B3: Descendants of Felix SHILVOCK of Stambermill, Stourbridge [Cath COLE / Margaret TAYLOR / Jackie THOMAS]

From CHART SV5B2:

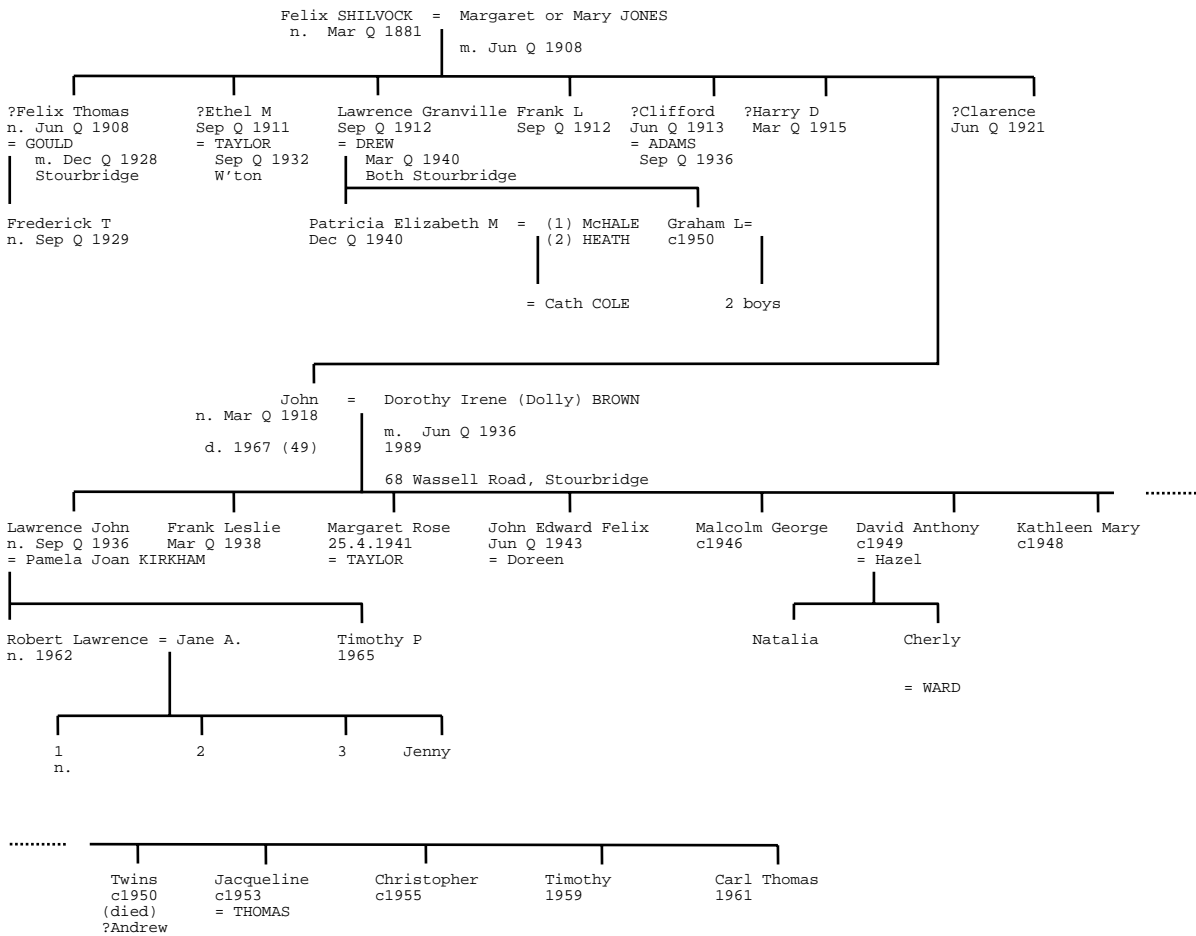

SHILVOCK ONE NAME STUDY

CHART SV5C: Descendants of John SHILVOCK & Elizabeth of Clent, Worcs. [Wm G SHILVOCK]

From CHART SV5B:

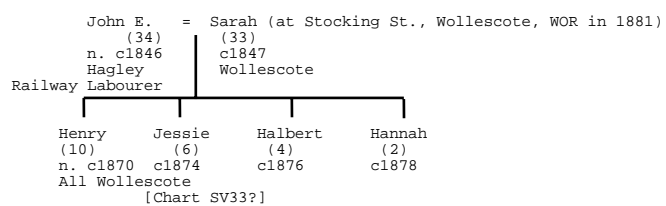

SHILVOCK ONE NAME STUDY

This could be the second marriage of William:

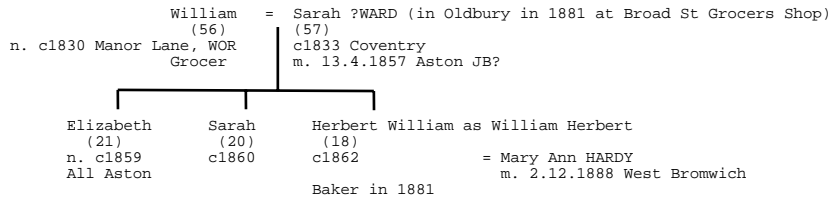

A different William - a Baker in 1901 Aston? Possibly children from list below:

William n. c1874 Labourer to Assayer Birmingham	?Clara c1876 Dressmaker Warley ?w/o William	Florence c1878 Photo Paper Sorter All Langley	Maud c1880 Machinist	Frank c1883 Unemployed	Herbert c1885 Errand Boy	Harry c1888	Selina c1889	Ethel c1892 Aston
--	---	--	----------------------------	------------------------------	--------------------------------	----------------	-----------------	-------------------------

SV6 Notes [by Peter AUSTIN]

William SHILVOCK: 5.10.1851-18.5.1936, Gun barrel maker & baker

He was a baker at 246, Great Lister Street, Nechells, Birmingham, near to Dartmouth Street.

Witton Cemetery, Birmingham:
 Plot no. 47/7829 bought by William in 1905. The interred are listed as follows:

- 01/07/1896 Selina SHILVOCK of 246, Great Lister Street, 47 years old
- 22/03/1900 Mary LANE of 4, Legge Street 77 yrs old (Selina's Mother)
- 11/02/1905 Maud Mary SHILVOCK 43, Great Brook Street 24 yrs old
- 08/03/1905 Herbert Alexander SHILVOCK 43, Great Brook Street 18 yrs old
- 07/07/1908 Harry SHILVOCK 43, Great Brook Street 19 yrs old
- 02/1927 Frank Joseph 3, Clyde Place, Upper Thomas Street 44 yrs old
- 23/05/1936 William SHILVOCK 3/11 Upper Thomas Street 87 yrs old

It is believed that the family left 246, Great Lister Street, because they thought it unlucky.

Maria PRICE was approximately 9 years older than William and had a son by a previous marriage or possibly illegitimate son called John FINCH.

SHILVOCK ONE NAME STUDY

CHART SV7: The New Zealand Connection (1) - Ancestry of Matthew SHILVOCK & Harriet BOWATER of C19th Clent, Worcs. [McKENZIE / WILSON]

From CHART SV13E:

At Walton Hill Church Row, Holy Cross, Clent in 1881:

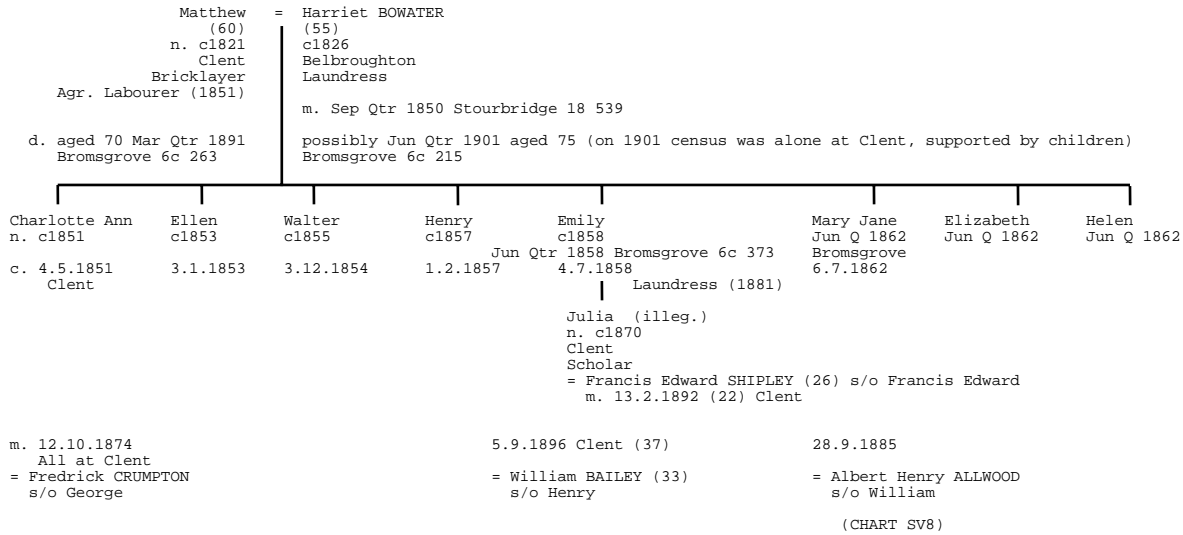

SV7 Notes

Descendant (exact connections unknown): Lois WILSON, 87 Ellicott Road, Hamilton, North Island, New Zealand
 N.B: only a single Matthew reference at St Catherine's, which allows exact marriage and death reference.
 Above details from 1881 Census at Church Row, Holy Cross, Clent. Other children presumed left home by 1881.
 Records confirm Julia is the daughter of Emily born when she was only 11/12 years old. Father not on M. Cert., but may be on B. Cert.
 In 1851: Holy Cross, Clent with un-named daughter 1 month old (Charlotte Anne, later known as Anne)
 In 1861: 5 Clent Village, St Leonard's Church Road

Matthew SHILVOCK	HD	M	41	Bricklayers Labourer	All WOR Clent, except Belbroughton
Harriett	Wife		35		
Ann	Dau		10	Scholar	
Ellen	Dau		8	Scholar	
Walter	Son		6	Scholar	
Henry	Son		4		
Emily	Dau		3		

In 1871: Matthew & Harriet with Ellen (18) Employed at home, Walter (16) Garden Boy/Servant, Emily (13), Jane (8), Julia (granddaughter)
 In 1881 at Church Row: Matthew & Harriet with Emily (23) unmarried & Julia (11 granddaughter)

CHART SV8: The New Zealand Connection (2) - Mary Jane ALLWOOD nee SHILVOCK of Blackpool, Lancs. [DAVISON]

From CHART SV7:

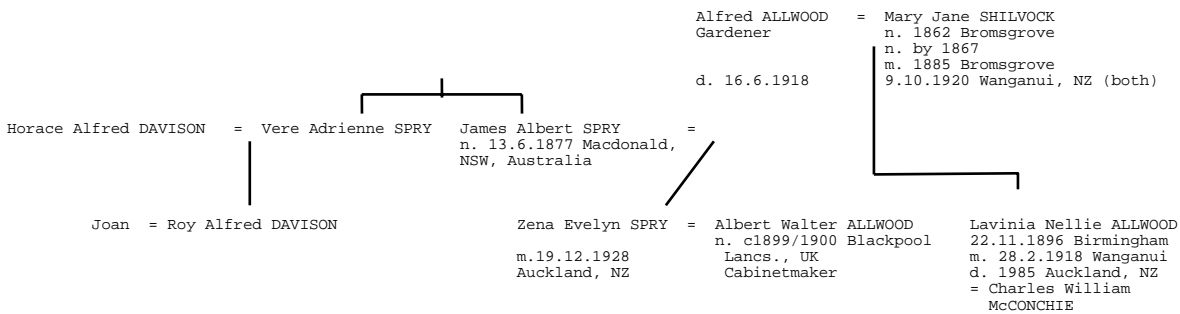

Lavinia is GM to Lorraine MacKENZIE (w/o Gary) in NZ
 Email: MACKENZIE-ASSOC(at)xtra.co.nz

SHILVOCK ONE NAME STUDY

CHART SV9: Descendants of Thomas SHELVOCK & Martha MOORE of Halesowen [WHITE / WILDENBERG / WYTHES] - SHILBURN alias

CHART SV9A: Ancestry of Thomas SHILVOCK/SHELVOCK/SHILROCK

Joseph "Josh" SHILROCK = Sarah [Ref. CHART SV4A]
 c1770
 |
 Thomas
 n. 28.4.1793
 c. 28.4.1799
 Halesowen Parish
 [CHART SV9B]

CHART SV9B: Descendant from Thomas SHELVOCKs First Marriage to Lucy HILL - SHILBURN alias

Thomas (SHILIOCK) n. c1792 Borough Nailers d. c1870		=	Lucy HILL c1792 m. 26.3.1815 Old Swinford (Lye in IGI) c1831 +20.7.1831 SHILCOCK	
--	--	---	--	--

Barnet/Barnett SHILCOCK n. c1816 c. 26.10.1817 Halesowen Borough Nailers	=	Martha HARDEMAN/ HARDMAN c1819 1.10.1820	Eli =	Fanny PARTRIDGE c1821	?Enoch =	Hannah/Anna HUGHES c1825 25.5.1828 = James ETHERIDGE m. Dec Qtr 1846 Dudley 18 369 (as SHELVOCK)	Leah c1825 25.5.1828 = James ETHERIDGE m. Dec Qtr 1846 Dudley 18 369 (as SHELVOCK)	Priscilla 14.11.1827 25.5.1828 = ?John HALL 30.12.1849 Dudley St Thomas Dudley 18 421	Caleb c1831
---	---	--	----------	-----------------------------	-------------	---	--	---	----------------

CHART SV9C CHART SV9D CHART SV9E Benjamin SHILVOCK (probably illegitimate) CHART SV4D (revised link)

Notes

1851 census in Birmingham Street, Halesowen: shows links for Leah -

James ETHERIDGE	26	Labourer & Nailers	(all n. Halesowen)
Leah	27	Nailers	
Edward	3		
Mary Ann	10 months		
Benjamin SHILVOCK	6	Wife's son (n. c1844) - No future family found	

CHART SV9C: Descendants of Barnet SHILVOCK/SHILCOCK & Martha HARDMAN

From CHART SV9B:

Family in Rumbow, Halesowen in 1851:

Barnet/Barnett SHILCOCK n. c1816/17 c. 26.10.1817 Halesowen Borough Nailers d. Dec Qtr 1886 Stourbridge 6c 81 aged 70 (Barnett widowed in B'ham Rd. Halesowen in 1881 with lodger Jane WALDRON, widow (59))		=	Martha HARDEMAN/HARDMAN c1820/25 Halesowen m. 21.3or6.1845 Halesowen Jun Qtr 1845 Stourbridge 18 590 Nailers d/o William, Nailers possibly Mar Qtr 1878 Stourbridge 6c 109 aged 56 (at New Road in 1861)	
--	--	---	--	--

Lucy n. 1845 Sep Qtr 1845 All Stourbridge 18 423 c. Halesowen Nailers m. 23.2.1865 Mar Qtr 1865 All Stourbridge 6c 178 = Timothy BRETTALL (19) Colliers of Borough	Ellen 1847 Jun Qtr 1847 18 439 13.5.1847 Nailers 17.3.1867 Mar Qtr 1867 6c 153 = Thomas MOORE (19) Nailers of Hasbury	Mary 1848 1Q 1849 18 505	Elizabeth 1851 2Q 1851 18 500	?Emily 1853	Phoebe 2Q 1855 6c 165 10.6.1855	Alice 12.1860 4Q 1860 6c 150 28.5.1863	Absolom 2Q 1863 6c 173
---	---	-----------------------------------	--	----------------	--	--	------------------------------

d. ?2Q 1855 ?Mar Qtr 1862
All Stourbridge
6c 77 6c 122
= ?Emily
Drillers of
Ingotts Cycle
Tube (1901)
In Halesowen

Notes

1853 child - Unknown. 8 children registered in Stourbridge 1852-54; only one of which is so far unaccounted for - Emily Sep Qtr 1852 6c 128

Both Absolom (19), Bricklayers Labourer & Alice (21) Gun Barrel Borer, are borders at h/o Edward TROLLY (brewer) in Spring Hill, Hasbury, 1881

In 1861 at 130 New Rd:

Barnett SHILVOCK	Head	M	43	All Nail Makers	All WOR Halesowen
Martha	Wife	M	35		
Lucy	Dau	U	15		
Ellen	Dau	U	12		
Mary	Dau	U	11		

SHILVOCK ONE NAME STUDY

CHART SV9D: Descendants of Eli SHILVOCK & Fanny PARTRIDGE

From CHART SV9B:



In 1861 at 31 Spring Hill:

Eli SHILVOCK	H	M	41	Nailer	All WOR Hasbury
Fanny	Wife		42	Nailer	
Joseph	Son	U	17	Nailer	
Mary Ann	Dau		15	Nailer	
Betsey	Dau		11	Horn Button Clipper	
Abel	Son		9	Horn Button Clipper	
Sarah	Dau		5	Scholar	
Rowland	Son		2	Scholar	

Edwin Aston/E. Birmingham News 1.4.1893: Edwin SHILVOCK sweep of 103 Booth St Handsworth charged with stealing parcel of grocery & articles, property of George COLBOURNE, Crocketts Rd Handsworth. In the 1891 census Eli SHILVOCK (sic) was shown as a sweep and widower aged 71 living at the house of John HOLT, aged 31 also a sweep. They were living at No. 1 Second Row Talbot Street. In the 1901 census, Edwin (mis-transcribed as SHILCOCK) was living with his wife, Charlotte, at 98 Devonshire Street, which is only 2 streets away from Talbot Street in Handsworth and within a mile of Booth Street where he was living in 1893. Crocketts Road, where George COLBOURNE lived, connects to Booth Street. As his father was a sweep, Edwin also worked as a sweep for a while although he was shown as a labourer at the Lead Works in 1901. Eli was listed as a pauper at the Poorhouse in 1901.

GenesReunited contacts: Linda WEBB & Jan CLEMENCE [Janclmence (at) aol.com]

Eliza c1840 (Q4 1839 18 418). Marriage (Bromsgrove Q2 1859 6c 563) = George WILLETTS. In 1861 in Hasbury, Eliza and George are living with Eliza's brother Joseph and future brother-in-law Joel HALL next door to her grandparents Benjamin and Mary PARTRIDGE.

SHILVOCK ONE NAME STUDY

CHART SV9E: Descendants of Enoch SHILVOCK/SHILOOCK & Hannah HUGHES

From CHART SV9B: - s/o Thomas SHILVOCK & possibly Lucy

In 1851, at Great Cornbow, Halesowen
 In 1861, at 131 Hagley Rd, Halesowen:

Enoch SHILVOCK	Head	38	Nailer	All WOR Halesowen
Hannah	Wife	34	Nailer	
Caroline	Dau	15	Nailer	
Eliza	Dau	9		
Ellen	Dau	7		
Joseph	Son	5		
Lucy	Dau	2		
Edwin	Son	3 weeks		

In 1881, Red Lion Inn, Hagley Road, Halesowen, Enoch & Hannah with daughter Lucy (22) & 4 GAUNT grandchildren (all of Rowley)

Enoch SHILOOCK	=	Hannah (alias Ann & Anna) HUGHES
n. c1823		c1826
Halesowen		Halesowen (Dudley given in 1851)
Hasbury Nailer		Nailer
Borough Nailer from 1858		m. 9.9.1844 Halesowen - Sep Qtr 1844 Stourbridge 18 488 (same ref. as an Isaac)
		d/o Benjamin (witn. Joseph & Maria HUGHES)
d. Sep Qtr 1881		possibly Sep Qtr 1886
Stourbridge 6c 62 aged 59		Stourbridge 6c 74 aged 63
		(at Hagley Road in 1871)

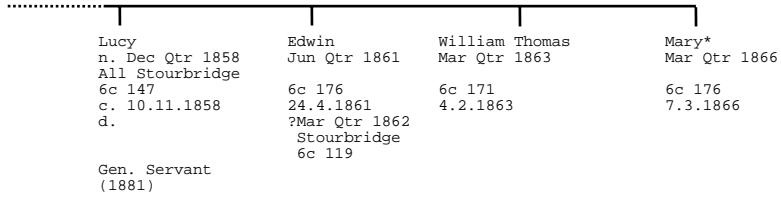
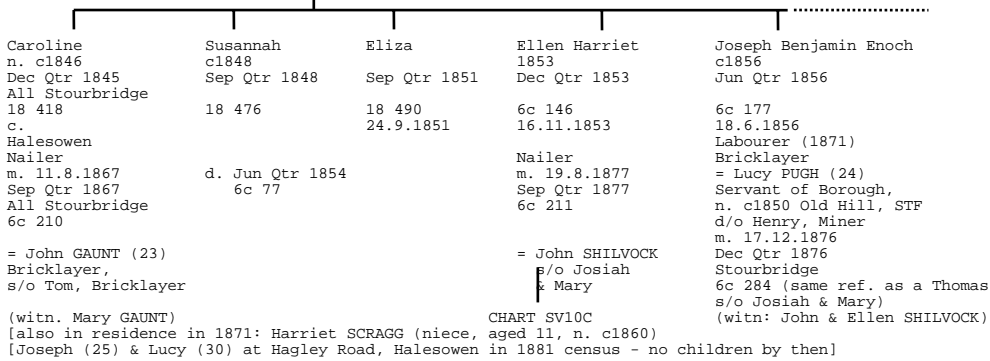

*Mary (15), Domestic Servant, at h/o Samuel GOODMAN (Solicitor's Managing Clerk), Hagley Road, Halesowen, in 1881 census

CHART SV9F: Descendants of Joseph SHILVOCK & Sarah

From CHART SV9D:

(at Hagley Road, Hasbury in 1881 with Hannah, Lucy, Joseph, George, Frederick, Betsy & Samuel + M-in-L Mary SHERRETT (71, widow of Solihull). Also in Hasbury in 1901 with Betsy (21) Giparmer & Samuel (20), Nail Warehouseman

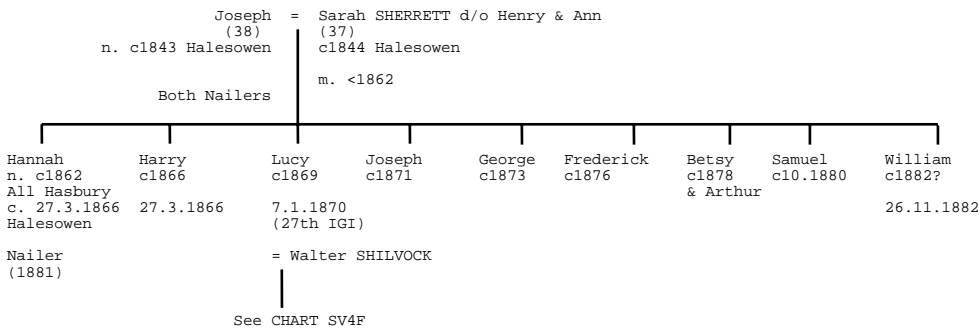

Harry: Servant at Clent Hill Lodge, Clent in 1881 (14) for the SMITH family
 Harry: Nailmaker in Gateshead, Durham (unmarried) in 1901.

SHILVOCK ONE NAME STUDY

CHART SV9G: Descendants from Thomas SHILVOCK's 2nd Marriage to Martha MOORE - California Connection [WHITE / WILDENBERG / WYTHES] - SHILBURN alias

[CHART SV9B shows first marriage]



SV9G Notes

Rumbow in 1841: (Thomas with second wife)

Thos SHILVOCK	45	Lab	All Y
Martha	30		
Leah	15		
Priscilla	12		
Caleb	10	(from first wife)	
Thomas	8		
Harriet	5		
William	3		
Joseph SHILVOCK	70	Lab	(was Joseph dead by 1841?)

In 1861 at 132 Hagley Rd:

Thomas SHILVOCK	Head	M	68	Brewer
Martha	Wife	M	50	Seamstress
Thomas	Son	U	28	Rivet maker

In 1871: Thomas as SHEHRIK (Wharf Clerk) in Handsworth with his sister & family HALLS. Ellen with 2 children are in Hasbury with Ellen's widowed father Thomas HACKETT.

In 1881: son George with parents as "SHELORCK" in Greenfield Road, Harbourne. As bootmaker, George still at same address with his widowed mother in 1891.

Thomas SHILVOCK on Christadelphian Membership Rolls for Birmingham Ecclesia 1873-1882:

- 1873 - at 100 Lancaster Street, Birmingham; Shoemaker
 - 1875 - at 10 Arches, Aston; Cobbler
 - 1877 - at Highfield Road, Halesowen; Shoe Dealer
 - 1879 - Harborne; Shoe Dealer
 - 1882 - Greenfield Road, Harborne
 - 1884 - Quadrant, Harborne
 - 1886 - No longer on roll
- Could be Thomas senior or Thomas Junior
Still modern day Christadelphian SHILVOCKs in Halesowen.

Account of Thomas SHILVOCKs conversion in 1872 to Christadelphian:

" BAPTISM 16 June 1872, aged 39. Former new connexion Methodist preacher. This case is interesting from several points of view. Brother SHILVOCK was a schoolmaster, and had to leave his school some two years ago on embracing the leading principles of the truth. Despairing of finding employment in that line, at all events on a footing admitting of religious independence, he set to work and learnt shoemaking as a means of obtaining a livelihood. This he has mastered and is now following with a measure of success, rejoicing as he says, that though he may not have risen in the social scale by the change he has acquired a position in which he is free to follow his convictions without consulting flesh and blood. It is interesting also to state that he came forward to obey the truth nearly eighteen months ago, and an appointment was made for his immersion, but at the last moment he faltered at the "exclusiveness" of the truth and stayed back. He thought the "harshness" of excluding the bulk of mankind (and many of them sincere) from eternal life on account of their ignorance, could not be of God. Study of the Scriptures since that time has enabled him to see differently and to accept this element of the truth though retaining commiseration for his kind "

SHILVOCK ONE NAME STUDY

CHART SV9H: Descendants of William Abel SHELVOCK & Mary Ann PARTRIDGE [PATTERSON / WHITE/ WILDENBERG / WOOD] - SHILBURN alias

William & Mary, based on 1861 census, were both 22 and Nailers at 118 Cemetery Lane, Halesowen (no children). Only William Charles is given as son of William Abel, otherwise all children were of William & Mary Ann. Ernest Benjamin was given as only Benjamin at baptism. This SHILVOCK family became SHELVOCK once Stateside.

From CHART SV9G:

William Abel n. 15.10.1838 Both Halesowen 4Q 1838 Stourbridge 18 395 d. c1926 Borough Nailers	=	Mary Ann PARTRIDGE c1838 d/o Charles PARTRIDGE & Mary LANE m. 1Q 1860 St Matthew, Wolverhampton as SHELVOCK bo Horseley Fields (double wedding with sister Harriet Ann, witnessing each others) 19.1.1901 = (2) Elizabeth UTTLEY
--	---	---

As SHELVOCK in the US

At LaSalle, IL on 1880 census

Mary Elizabeth "Lizzie" n. 17.6.1861 c. 29.9.1861 All Halesowen m. = Arthur MOORE d. 27.3.1933 San Francisco n. Halesowen 28.2.1862	William Charles 12.3.1864 8.3.1865 16.2.1920 San Jose = Blanche WILDSMITH	(Ernest) Benjamin 5.3.1866 Love Lane 18.4.1866 imm. 1869 Machiner Railwayman d. 14.3.1957	=	Sarah Ann ETHERIDGE 20.3.1867 Love Lane 18.4.1866 imm. 1872 m. c1889 in US 9.8.1924	Albert "Bert" 18.6.1870 Marseilles, IL 15.6.1892 San Jose unmarried	Jennie Ethel 18.4.1872 = (1) Wm WITHYCOMBE no issue = (2) David BAKER no issue m. 28.7.1908 Santa Rosa 12.1.1934 Oakland
---	---	--	---	---	---	---

Ruth
n. 18.1.1898
d. 7.7.1925
William
unmarried
Fireman

Harriet Ann "Annie" n. 15.10.1873 All Marseilles, IL m. = Leonard HELSBY d. 21.4.1952 Oregon City	Marian "Mae" 7.8.1875 = Harold STEVENSON no issue 21.1.1956 Both Oakland	Robert "Bob" 24.3.1877 24.5.1914 young	Martha 1879	Catherine E. "Cathy" 17.7.1881 8.3.1911 Oregon City	= John AMBLER Jr.
--	--	--	----------------	---	-------------------

Dorothy Isabelle = Stanley P. WHITE
Larry Ralph WHITE (n. 8.5.1945)
Oakland, CA

Family moved from San Jose to Oregon City when the mills closed. The girls worked in the woollen trade.

family at 413 Landa Ave., Joliet, IL in 1900

Viola n. c1888 d. young	Thorald 26.3.1890 [CHART SV9M]	William Albert 7.2.1891 Joliet, IL 4.11.1965	Leila Adele WHEELER 22.11.1892 Cedar Rapids, IO 6.6.1963	George Leslie 22.10.1893 = Eva T. WATSON 20.2.1965 + Oak Hill Cem. San Jose	Myrtle 24.7.1899 = WATERS 10.2.2001 San Jose	Thelma M 10.3.1910 20.5.2003	Ernest Benjamin 12.3.1912/3 (see notes) 14.3.1941 (unmarried)
-------------------------------	--------------------------------------	---	---	---	--	------------------------------------	--

Doris Adelle n. 20.8.1915 = Olean CAGLE d. 10.2003	Joy D 24.10.1917 = Cleon J. BURKE 8.3.1987 = LEONTI	Sheldon Orrin 26.8.1919 San Luis Obispo, CA 6.11.1993 = (1) Jeanne Kathryn ELVEY n. 19.1.1920, San Jose, CA m. 14.3.1942 San Jose d. 21.1.2005	Betty Ann 13.3.1922 = ACKERMAN 22.7.1948	Bernis Mae 13.3.1922 = Ken JORGENSEN 2.10.1987 [Lois Jorgenson PATTERSON]	William Elsworth 30.9.1923 Yreka [CHART SV9I] Summer 2002	= Lillian HITZEMAN
---	---	---	---	---	---	--------------------

Edward Cornell n. 30.9.1923 d. 10.3.1997 Santa Clara, CA = Patricia TRESADEN	Leila Lee (Shine) 31.7.1925 = BACHMAN 18.9.1964	Harry Benjamin 23.4.1930 at Blaine, WA d. 1.12.2001 = (1) Lee = (2) Patsy
--	--	--

= (2) Margret, Polynesian, a native of Truk Island
d. 1992

Leila Christina
n. 22.10.1952 Truk Island
= BAKER (lives on Guam)

Kurt Sheldon = Carol
at Seattle, WA
d. 2.5.2006
while on holiday in Amsterdam

Margaret Jeanne ("Peggy") n. 25.7.1941 San Jose, CA d/o Jeanne & adopted by Sheldon = (2) ?DAVIS = Clyde Price BURNS m. 19.8.1972 Siskiyou Co.	Renee Adele 18.1.1944 San Jose, CA = (1) Angela n. 1962 = (2) = (3) Bob WILDENBERG m. c1983 live in Yorba Linda, S. CA, USA	Robert Edward 1.4.1952 San Jose, CA [CHART SV9J]	Elisabeth Carol 15.12.1955 Yreka, CA (remainder) = REIS	Donald Albert 11.1.1958 [CHART SV9K]	Harry Joseph 20.9.1960 [CHART SV9L]	Lenora Kathryn 28.1.1963 = WOOD
---	---	---	--	--	---	---------------------------------------

SV9H Notes

Family of William Abel & Mary Ann were in 1870 & 1880 census reports for La Salle County, Manlius Township, Marseilles, IL Given as SHELLWELL in 1870. Stories include Robert always being bailed from jail, and whether Catherine's second name was Edna or Elizabeth. Census Place: Manlius, La Salle, Illinois
Source: FHL Film 1254223 National Archives Film T9-0223 Page 361B

SHILVOCK ONE NAME STUDY

Relation Sex Marr Race Age Birthplace

William SHELVOCK Self M M W 42 ENG
Occ: Blacksmith Fa: ENG Mo: ENG
Mary SHELVOCK Wife F M W 42 ENG
Occ: Keeping House Fa: ENG Mo: ENG
Elizabeth SHELVOCK Dau F S W 18 ENG
Occ: At Home Fa: ENG Mo: ENG
Charles SHELVOCK Son M S W 16 ENG
Occ: Miller'S Apprentice Fa: ENG Mo: ENG
Benjamin SHELVOCK Son M S W 14 ENG
Occ: At Home Fa: ENG Mo: ENG
Albert SHELVOCK Son M S W 10 IL
Occ: At Home Fa: ENG Mo: ENG
Jennie SHELVOCK Dau F S W 8 IL
Occ: At School Fa: ENG Mo: ENG
Annie SHELVOCK Dau F S W 6 IL
Occ: At School Fa: ENG Mo: ENG
Marian SHELVOCK Dau F S W 4 IL
Fa: ENG Mo: ENG
Robert SHELVOCK Son M S W 3 IL
Fa: ENG Mo: ENG
Martha SHELVOCK Dau F S W 1 IL
Fa: ENG Mo: ENG
Alfred PARTRIDGE Other M S W 22 ENG
Occ: Blacksmith Fa: ENG Mo: ENG
1900 census - family living on Miller Street, San Jose, CA

The obituary George Leslie SHELVOCK from the San Jose Mercury news:

"SHELVOCK -- In Palo Alto, Feb. 20 [1965] George L. SHELVOCK, loving husband of Eva T. SHELVOCK; loving stepfather of Donald Foley, Helen Childrey and Olive Roumasset, all of San Jose; dear brother of William SHELVOCK of Yreka, Myrtle WATERS of Paicines and Thelma SHELVOCK of Paso Robles. Veteran of WWI. A native of Illinois, age 71 years."
Eva previously married to Michael FOLEY Jr. The two girls lived with George & Eva, while Donald dropped in to visit all the time (believed to be living with his FOLEY grandmother several blocks away).
After Uncle George died, Eva married Charles HANDL so when she died in Monterey Co. 6.5.1987 she died under that name. She, however, is buried in the SHELVOCK family plot in Oak Hill Cemetery in San Jose, CA.

SHELVOCK - In San Jose, January 19, 1901, Mrs. Mary Ann SHELVOCK, beloved wife of William SHELVOCK and dearly beloved mother of Mrs. Lizzie MOORE, Mrs. Jennie WITHYCOMBE, Mrs. Annie HELSBY and Charles, Benjamin, Marion, Robert and Cathie SHELVOCK, a native of Halesowen, England, aged 62 years, 2 months and 18 days.

Friends and acquaintances are respectfully invited to attend the funeral from 50 Miller street to-morrow (Monday), January 21, 1901, at 2:30 p.m.
SOURCE: San Jose Daily Mercury, January 20, 1901, Sunday morning.

"Ernest" Benjamin SHELVOCK was Benjamin SHELVOCK only in all his documents except his death certificate. The family seems to have added the Ernest as a middle name. His birth certificate, marriage certificate and even his will do not add Ernest.
He was born in San Jose, CA 12 Mar 1913 (not 1912 as is on his death certificate). Sarah Water SCHMIDT has her grandfather's diary, which states: March 12-1913 Brother born 10:30 a.m. - 7 1/2 lbs. Two days later Bill (the new baby's older brother) and Grandma Etheridge arrive from Joliet to "see" the baby at 5:05. (her grandfather - Benjamin was a railroad man and time was important.)

Modern Florida descendant is Cindy WRIGHT born Jessica Lenore SHELVOCK - 19405 Pine Tree Road Odessa, FL 33556. Tel: (813) 920-6974. Looking to find her birth parents. She was born at Booth Memorial Hospital in Chicago on September 14, 1968. She was put up for adoption. She found her birth mother as one of the SHELVOCK family in California, although the identity currently remains secret.

SHILVOCK ONE NAME STUDY

CHART SV9I: Descendants of William Elsworth & Lillian SHELVOCK of California

From CHART SV9H:

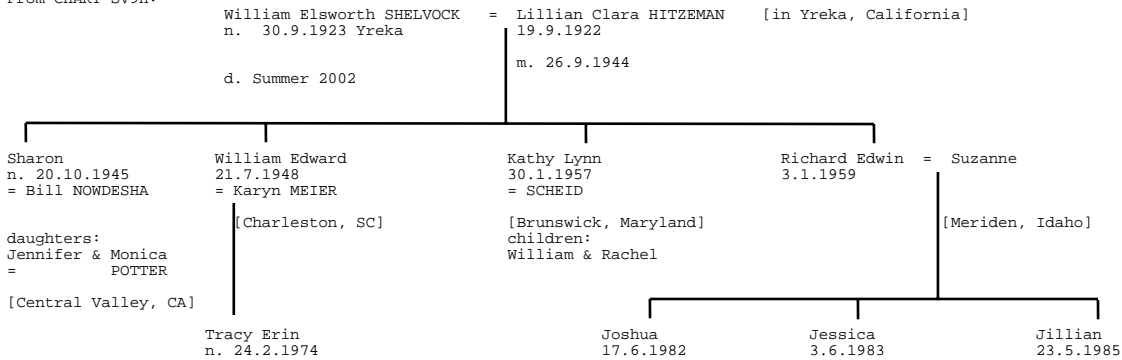
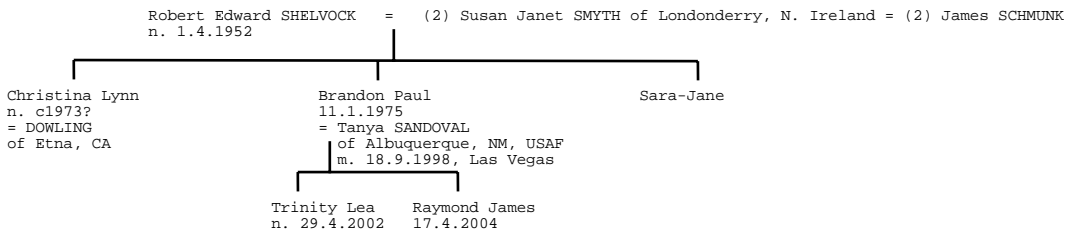

CHART SV9J: Descendants of Robert Edward & Susan SHELVOCK of Barstow, California

From CHART SV9H:



Also have 3 adopted children in 1995:
 Robert Edward II (1989) ["Crazy-lic" on MySpace]
 Corey Lee (boy) (1991) [MySpace] - Ansbach, Germany
 Heidi Lynn (1991) [MySpace]

Robert: 424 Fenoak Drive, Barstow, CA 92311
 Brandon & Tanya, New Mexico: on the MP3.com music site, as band members of "Toil"- singer Brandon SHELVOCK. [both MySpace]
 Brandon SHELVOCK at Kirtland Air Force Base, listed as part of the "NM Directed Energy Directorate" - now Mechanical Designer

CHART SV9K: Descendants of Donald Albert & Kathy SHELVOCK of California

From CHART SV9H:

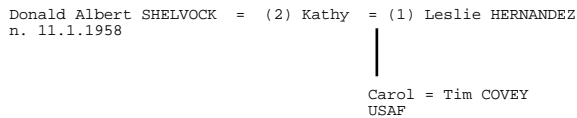

Air Force Airman Carol SHELVOCK has graduated from military training at Lackland Air Force Base in San Antonio, Texas. She is the daughter of Donald SHELVOCK of Gazelle, Calif., and Leslie HERNANDEZ of Bentonville. Shelvoek is a 2000 graduate of Yreka High School in California. [SPECIAL TO THE MORNING NEWS - SUNDAY, APRIL 15, 2001]

CHART SV9L: Descendants of Harry Joseph & Charlotte SHELVOCK of Grenada, California

From CHART SV9H:

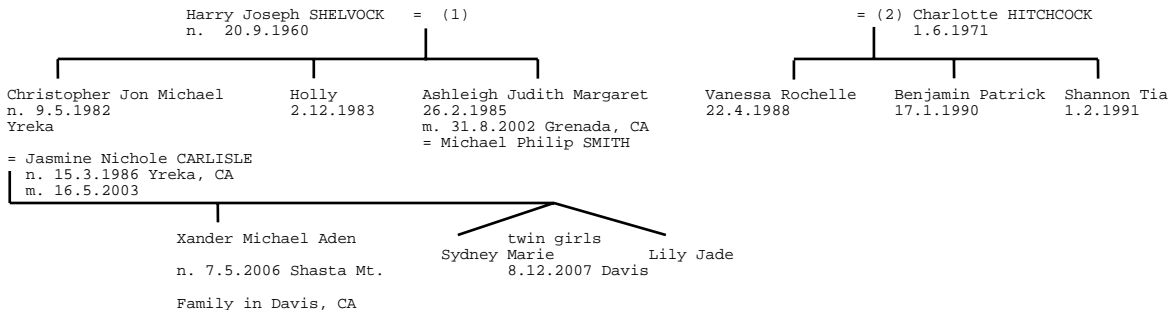

from SISKIYOU COUNTY BIRTH RECORDS & MySpace contacts: Jasmine, Shannon, Vanessa, Ben [in US Navy Boot Camp 2008], Char.

SHILVOCK ONE NAME STUDY

CHART SV10: The First Chicago, Illinois SHILVOCK Connection [RCS / Ann WILLIAMS]

CHART SV10A: Descendants of William SHILVOCK & Mary [RCS]

[possibly s/o Samuel & Sarah - Chart SV12A]

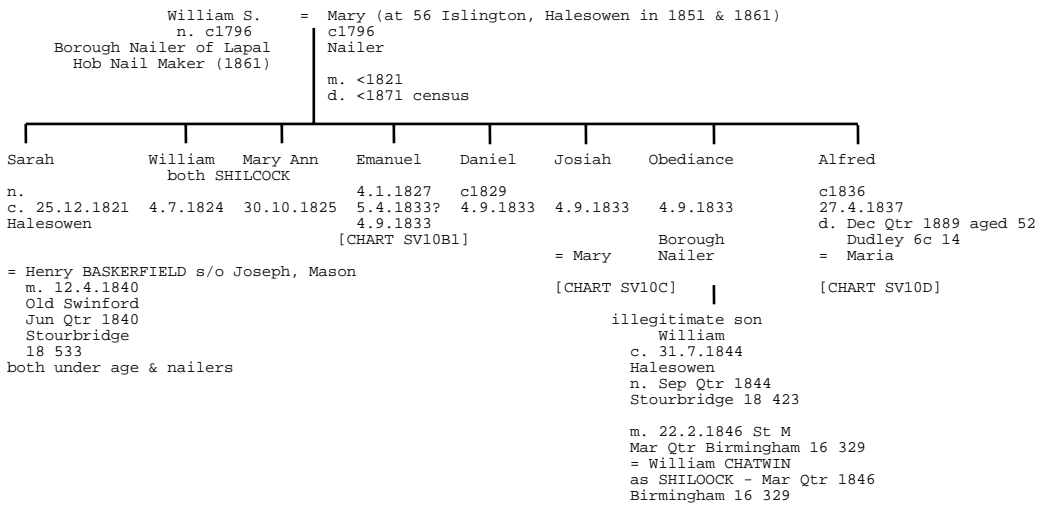

Notes

1841 Halesowen:
 William SHILVOCK 40 Nailer All Y
 Mary 40
 Isiah 15
 Ann 15
 Obedience 10
 Daniel 10
 Emmanuel 5
 Alfred SHILVOCK ?
 Isiah above could be Josiah

William given as aged 39 (?59) in 1851 census = n. c1792
 Same census gives visitors William HACKETT (7) and Elizabeth BASTERFIELD (8) both n. Halesowen. BASTERFIELD should be BASKERFIELD, children of elder daughter Sarah. Not given as grandchildren. BASTERFIELD family were lodgers next door in the house of Ann SHILVOCK, an 80 year old Pauper & Nailmaker. Perhaps William's mother or other elderly relative?

William S. (84), n. c1796 Halesowen, widower, past work given as nail maker, in 1881, living in Hasbury at Bundle Hill House, Cottage at Back, as boarder with Henry & Sarah BASKERFIELD.

HACKETT connection may be related through a sister of William? Mary = Samuel HACKETT 11.2.1821 St Martin, Birmingham [WILLMORE]
 Ancestry to be confirmed:
 Samuel HACKETT = Mary SHILVOCK m. 11.2.1821
 Son Charles HACKETT = Elizabeth WOLLOXALL m. 25.12.1847
 Son George HACKETT = Ellen LEA m. 31.3.1872
 Son Alfred HACKETT = Hannah Edna WILLIAMS m. 12.9.1903
 Son Walter HACKETT = Gertrude Alice May MOLE m. 5.8.1933
 Daughter Sheila Margaret Ruth HACKETT = WILLMORE

GenesReuntied connection: Mary = Samuel HACKET [David MOTKIN / Linda GOODE] also has an Anne SHILVOCK = Job HACKETT (d. c1889)

Job HACKETT n. 21.7.1822 Halesowen, m. Anne SHILVOCK (n. 25.12.1824 Halesowen, d/o William SHILVOCK.
 1851 Census gives Job's wife Ann as 24, and 1861 says 33.

SHILVOCK ONE NAME STUDY

Chicago Stories:

William Henry is listed as "saddlery hardware" at the rear 15 S. Canal (business) and home address 1339 N. Talman Ave., in 1905. In 1910 family was at 1392 N. Campbell Ave.

The FHL index to death register, Chicago, 1871-1933 that should be fruitful, is black/blurred beyond reading.

Burials are in North Chicago at Irving Park and Elmwood Park Cemeteries.

Stanley talked of helping his father (Wm Henry) farm in southern Illinois (helping to haul turnips and potatoes to the city). Between 1905 & William's death in 1927 (by acute cardiac dilatation; chronic myocarditis) their location is unknown as they were not on or missed in the 1910 & 1920 census.

Donald & Donna SHILVOCK of Glenview, Illinois:

Plumbing supply company called SHILVOCK Co. Inc./SHILVOCK Plumbing Supplies run by Donald and 3 of Ernest's children (Elizabeth, Mildred, Edward). Ernest Jr. d.16.9.96 of Lou Gehrigs Disease. Connie n. 1960 and Edward n. 1957. (data from Micki SHILVOCK Email: BooneCo(at)aol.com) SHILVOCK Company Inc, 312-384-8770, 2226 N Milwaukee Ave, Chicago, IL, 60647

Rumour surrounding Albert M. concerns the plumbing business he ran with Ernest where Albert struck Sidney on the head killing him. Albert testified at the inquest which was ruled "accidental" after he stated Sidney had tripped over a car rail and/or been killed by a tramcar. Nothing else is known of Albert. Sidney died of bronchial pneumonia & brain haemorrhage. Inquest was held 25.5.1926

Cecil R. had a marble factory in Elkhart, Indiana where he did very well financially.

Josiah may have been known as Jack, but not found in Chicago on 1910 & 1920 census.

Bill SHILVOCK - who? pallbearer at funeral of Nathan Boone HOWARD [20 Dec 1860 - 11 Feb 1949 [unmarked Grave at Jeff Cemetery].

Unknown: Jean 1918-96 Morton, IL

Unknown brother's owned "Great Lakes Paint and Varnish" in Chicago. One brother of William SHILVOCK (grandfather) was killed after being pushed or fell into a vat of varnish at Great Lakes Paint and Varnish. This incident seemed to have happened under very mysterious circumstances. Great grandfather William C. SHILVOCK had numerous patents for inventions. One being a back-water valve installed in sewer systems. There was also the SHILVOCK Foundry in Chicago that made many grates, sewer screens, and manhole covers for Chgo. which are still used today.

In 1920, a group of men in Chicago felt the need for an organization where they could meet and discuss common problems relating to paint and varnish products. John R. MacGregor was selected as the most suitable person to make initial contacts among the local industry people. As a result of his efforts, a meeting was held on December 17, 1920, at the Hamilton Club in Chicago, which saw the founding of the Paint and Varnish Superintendents' Club of Chicago. This new club, which prospered and grew from the outset, subsequently became known as the Chicago Society for Paint Technology. The Society continued to flourish and in 1973, in keeping with the modern role of the industry, the name was again changed to the Chicago Society for Coatings Technology. Today, the Chicago Society is among the two largest of the 26 societies that are affiliated with the Federation throughout the U.S., Canada, Mexico, and the United Kingdom. Among those present at the founding were
.....Jack SHILVOCK

SHILVOCK ONE NAME STUDY

CHART SV10B3: Descendants of Stanley Melrose SHILVOCK & Lillian TIMM of Chicago [Norma THOMPSON]

From CHART SV10B1:

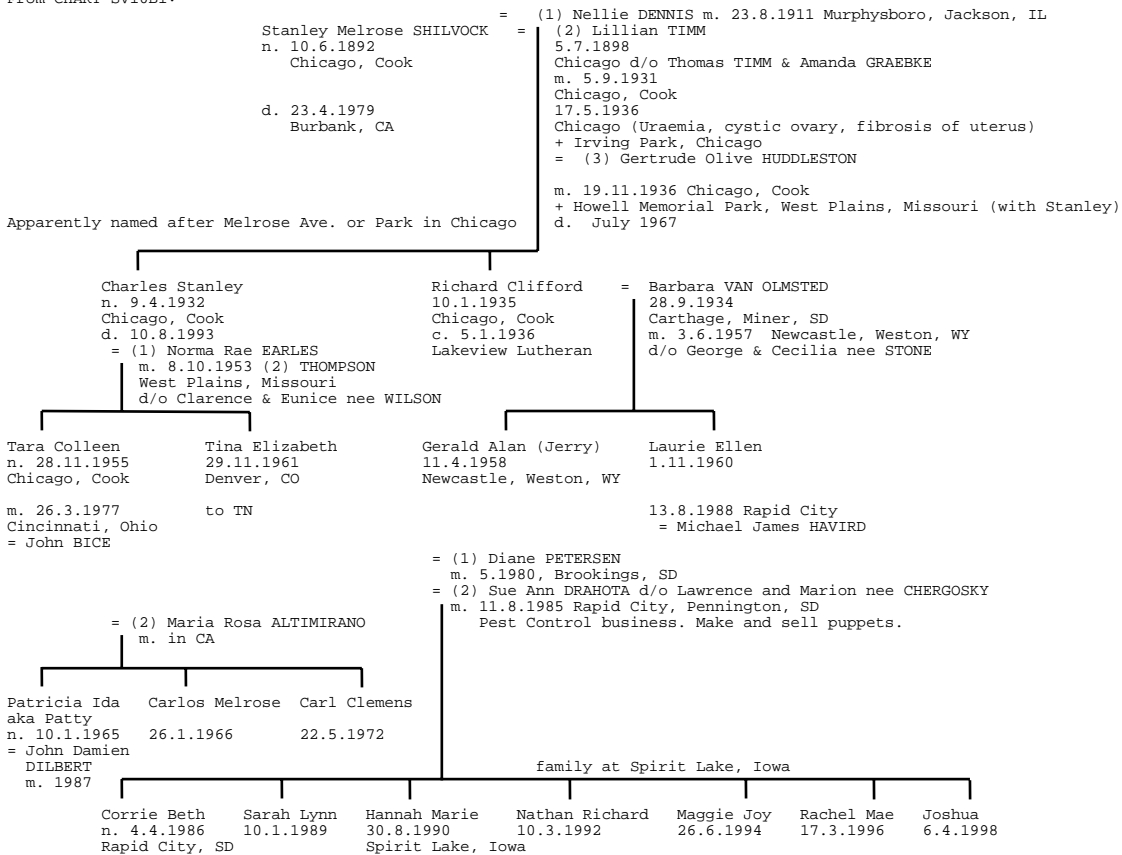

Norman THOMPSON: 282 Bell St. Ashland City, TN. 37015 (615)792-3477.

CHART SV10B4: Descendants of Ernest SHILVOCK & Mildred of Chicago

From CHART SV10B1:

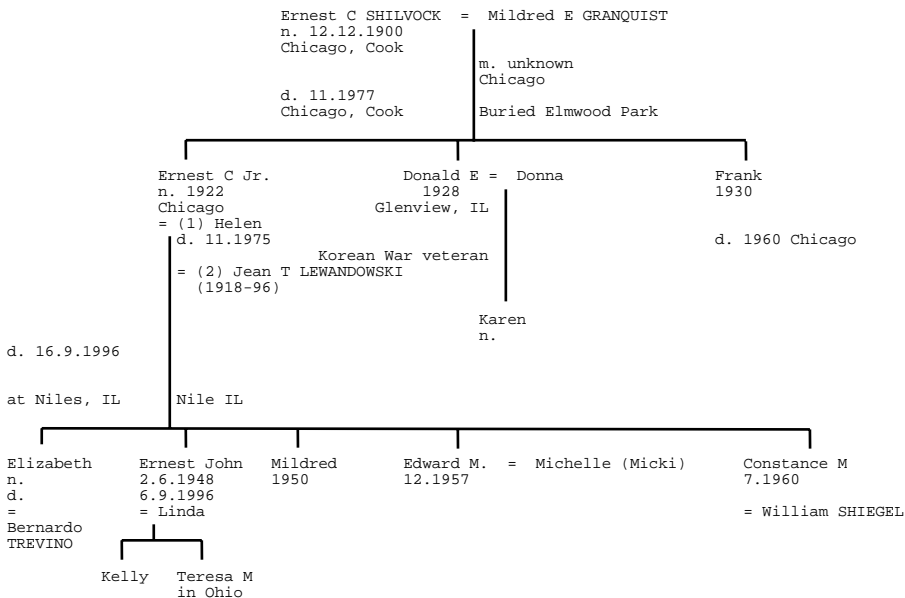

Ernie & Albert's plumbing business still being run by Ernie's sons.
 Ernie had a summer home in Algonquin, IL on the Fox River.
 Dora SHILVOCK, Nurse at Tuloso-Midway Independent School District
 From the US Social Security Death Benefit listing:
Alfred SHELVOCK; 25 Jul 1910 - Feb 1985; Atlanta, GA
Helen SHELVOCK; 2 Apr 1901 - Mar 1975; Atlanta, GA (this could be Helen above, but why GA, and who is Albert?)

SHILVOCK ONE NAME STUDY

CHART SV10B8: Descendants of Albert Donald/Donald Albert SHILVOCK of Chicago

From CHART SV10B1:

May have emigrated earlier with his older brother William Henry & family, before the rest of his family arrived.

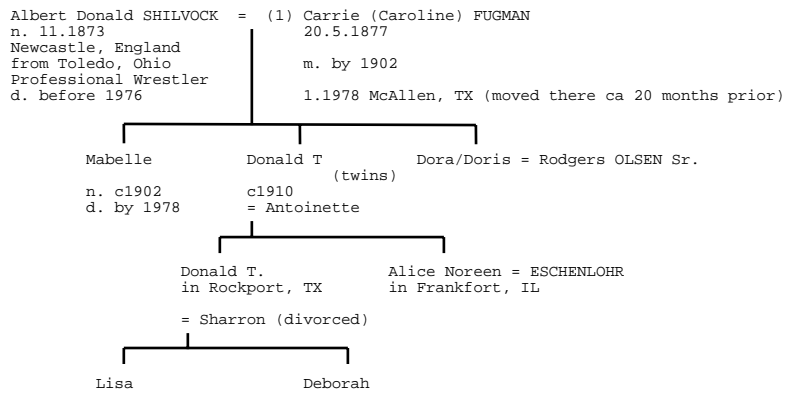

In 1900 living near Emmanuel at 1229 Dickens Ave.

In 1905 Chicago Head of Household Directory, as "ice" with Emmanuel at 1183 N 50th Ct.

1920 - Albert Donald not found, but Carrie + 3 children at 2252 Lamon Ave., at home of Charles FUGMAN

Donald may have been a sheriff in a town in southern Illinois - Cragin near Elmwood Park

In 1960's, were at Crystal Lake, IL.

SHILVOCK, Deborah A, Miss: 15961 Le Claire Ave 3A, Oak Forest, IL 60452

SHILVOCK, Lisa A: P O Box 130673, Tyler, TX 75713

SHILVOCK ONE NAME STUDY

CHART SV10B9: Descendants of John (Jack) SHILVOCK & Emma of Chicago

From CHART SV10B1:

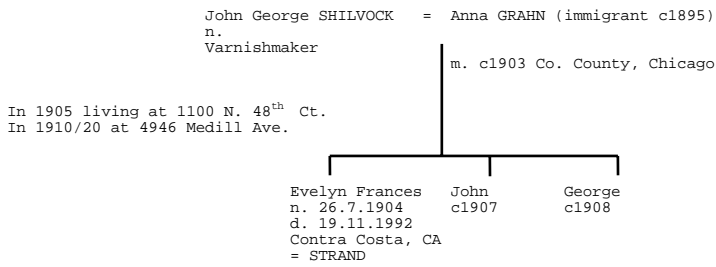

George called for coroner's duty in 1953 concerning major fire & explosion. (Newspaper article)

CHART SV10B10: Descendants of Archibald SHILVOCK & Daisy of Chicago

From CHART SV10B1:

Part owner of Great Lakes Paint & Varnish Co.

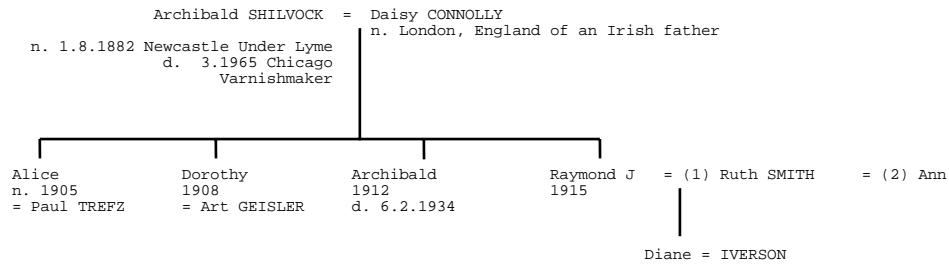

R J at Imperial Golf Course, Naples, Florida
 but commutes to IL to his paint & varnish business

In 1905, as moulder, at 2264 St. Paul Ave.
 In 1920 with 3 children at 3755 Richmond St.

CHART SV10B11: Descendants of Ernest & Lizzie SHILVOCK of Chicago

From CHART SV10B1:

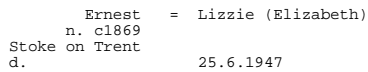

Ernest was a railway conductor.

CHART SV10B12: Descendants of Francis Aloysius Frank) & Clara SHILVOCK of Chicago

From CHART SV10B1:

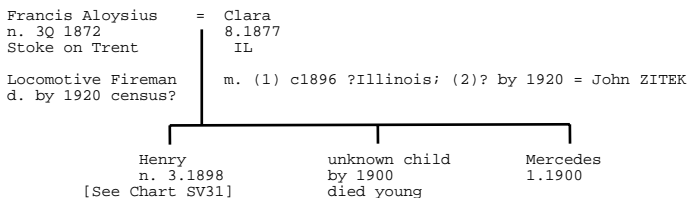

On 1900 census he immigrated in 1880.

SHILVOCK ONE NAME STUDY

CHART SV10B13: Descendants of Josiah (Joshua) SHILVOCK of Chicago

From CHART SV10B1:

After 1905 employer Westinghouse moved Josh to Attica, New York

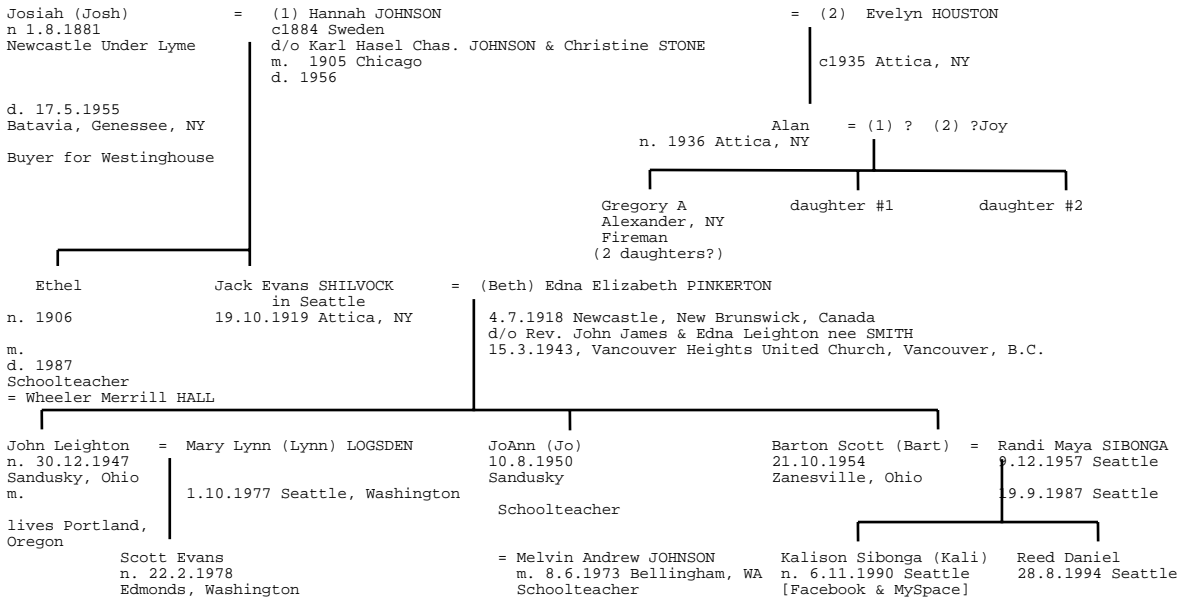

Uncertainties:

Josiah = (1) ?Jennie KIRKPATRICK
 Josiah = (3) ?Lucy from New York

Batina SHILVOCK (n. 3.1871 New York) = Ellen (n. Ireland) in 1900 Chicago
 Not found in IL or NY in 1880 and subsequently to 1900.
 Either died or changed name?

Greg son of Alan: at City of Batavia, New York State - Fire Lieutenant, Technical Rescue Officer & Water & Ice Rescue Officer

The Attica News - Attica, Wyoming Co. NY: June 24, 1909;
 J. V. SHILVOCK fell from his bicycle Saturday and broke his collarbone.

IN THE INTERMEDIATE COURT OF APPEALS OF THE STATE OF HAWAII

Case Law in Support of our Opinion Our decision is supported by, and we agree with, the opinion of the Illinois Appellate Court in SHILVOCK v. SHILVOCK, 31 Ill. App. 2d 254, 175 N.E.2d 272 (1961). In SHILVOCK, the husband and the first wife were divorced in 1957. The divorce decree required that if the husband predeceased the first wife, the first wife would be entitled to one-half of 1,393 shares of stock that he owned. The husband's will placed the stock in trust and directed the trustee to convey one-half of the 1,393 shares to the first wife. The husband then married the second wife. Upon the husband's death, the first wife petitioned in the divorce case for enforcement of the divorce decree. The executor/trustee of the husband's estate/trust responded that the second wife claimed an interest in the stock. The court ordered compliance with the divorce decree. When the executor/trustee failed to comply, the court responded to first wife's petition by ordering the conveyance to be made within ten days. Before the conveyance was made, the second wife sought leave to intervene on the basis that the stock was an asset of the estate and that an award of the stock to the first wife would diminish her share. The second wife appealed from the denial of her request for intervention and from the order mandating the conveyance to the first wife. On appeal, the appellate court concluded that "both the [Family] and Probate Courts could properly exercise jurisdiction over the subject matter of this controversy. Concurrent jurisdiction of the courts over the identical subject is not unusual and occurs frequently in probate matters." Id. at 260, 175 N.E.2d at 275. It also concluded that the divorce court's denial of the second wife's petition to intervene was in error. Id. at 264, 175 N.E.2d at 277. However, after deciding that the points raised in her petition to intervene were without merit, it concluded that the error was harmless.

SHILVOCK ONE NAME STUDY

CHART SV10C: Descendants of Josiah SHILVOCK & Mary PARTRIDGE of Halesowen [RCS]

1851: Josiah & Mary (both 28 & both Nailers) with Alfred (5) & Mary (10 months) at Stourbridge Road

1861: at 102 Islington
 Josiah SHILVOCK, Head M 37 Post Messenger
 Mary Wife M 38 Nailer
 Alfred Son U 15 Nailer
 Mary Dau U 10 Nailer
 Thomas Son 8 Nailer
 John Son 7 Scholar
 Martha Dau 5 Scholar
 Jane Dau 3
 Edward Son 1

1881 Halesowen Census at Islington - Josiah(post messenger) with wife Sarah (nail forger) and son William (17, Axle Turner)

Josiah = (1) Mary PARTRIDGE = (2) Sarah
 n. c1823 c1822 (61 in 1881)
 c. 4.9.1833 c1819, Rowley Regis, Staffs.
 Borough Nailer m. 2Q 1844 Stourbridge 18 605 >1866
 Post Manager (1861)
 Postman (1869)
 Will Sept 1881 (p.547)
 d. Jun Qtr 1881 Stourbridge d. 1866
 6c 80, aged 58 (at Islington in 1861)

Alfred = Ellen HODGKINS (at Hagley Road in 1882, Spring Hill 1883) Mariann
 n. 1845 n. c1846 (on Halesowen census in 1881 with Arthur, Walter & Beatrice 1847
 Both Halesowen c. 21.8.1845 & M-in-law Elizabeth WITHERS, widow 55 (her 1st marriage)
 ?Dec Qtr 1845 Aston 16 163 Ellen, illeg. d/o Betsy. Elizabeth = Henry WITHERS m. 31.3.1850 Dudley
 Nailer (1861)
 Foreman (1883)
 Hawne Railway Porter(1871/81) Dress Maker of Borough (1881)
 Office Clerk (1869) m. 7.3.1869 Halesowen (withn. Mary SHILVOCK)
 Mar Qtr 1869 Stourbridge 6c 185 (next entry to a Henry)
 d. poss. 4Q 1899 6c 86 Stourbridge aged 54

Harry n. All Halesowen c. 26.2.1871 Halesowen d. Jun Qtr 1878 Stourbridge 6c 95, aged 7 5.2.1878	Arthur 1872 12.2.1873 alive in 1881	Walter 1874 5.1.1875 (9.8.1876) 2nd Bapt.?	(Arthur)	Albert Victor 8.2.1878 Mar Qtr 1878 Stourbridge 6c 110	Beatrice 1879	Sydney 1.11.1882 Jun Qtr 1883 Stourbridge 6c 82, aged 2	Evelyn 20.2.1883 Jun Qtr 1895 Aston 6d 242 aged 8
--	---	--	----------	--	------------------	---	---

From CHART SV9B:
 Enoch SHILVOCK = Ann (Hannah)
 Borough Nailer

Mary n. 1850 = Ellen Harriet SHILVOCK (23)
 Dec Qtr 1853
 6c 146
 c. 16.11.1853 Halesowen
 Nailer of Borough
 m. 19.8.1877 Halesowen
 Stourbridge 6c 211
 (witnesses: Alfred & Lucy SHILVOCK)
 on 1881 census both aged 27,
 with Arthur (1)
 family as SHILSCOCK at Hawne
 in Hawne in 1901 with Minnie & Frederick

Thomas 1852 Halesowen
 Mar Qtr 1852
 All Stourbridge
 6c 149
 Nailers in 1861
 Engine Turner of Hasbury
 = Harriet Ann GROVE (21)
 Dressmaker of Borough,
 d/o Joseph, Builder of Borough
 m. 3.12.1876
 Stourbridge 6c 284
 (same as Joseph B E s/o Enoch & Hannah)
 withn: Benjamin GROVE & Emma SHILVOCK
 1882: at Grays Hill Lane, Borough
 (at Grange Mill Lane, Halesowen in1881)

Edith n. c1877 All Halesowen c. 12.12.1878 at Cemetery Lane, Borough (1882), and Bloomfield St (1883-93) [1882 couple may be different]	Amy 1879 14.5.1879 Nurse (1901)	Emily 29.10.1882 Dressmaker (1901)	Arthur n. 2Q 1879 6c 168 St c. 9.9.1880 d. 2Q 1900 6c 88 aged 21	Kate 3Q 1880 6c 153 St 9.9.1880 1Q 1881 6c 79 aged 0	Emily 29.10.1882 d/o Gardener	May 4Q 1882 St 6c 150 27.5.1883 m. ?Jun Q 1916 = ?CARTWRIGHT	Minnie c1885? 31.6.1891 Jun Q 1919 = JOHNSON	Frederick 4.2.1893
--	--	--	--	--	-------------------------------------	---	--	-----------------------

Martha n. Mar Qtr 1856 All Stourbridge 6c 170 c. 26.3.1856 Halesowen	Jane Jun Qtr 1858 6c 155 7.4.1858	Edward Jun Qtr 1860 6c 160 25.12.1860	Mary c1861	William King SHILVOCK Sep Qtr 1863 6c 150 5.8.1863 d. 1942 Vancouver, BC = Mary PRICE m. March 1882	Caroline Mar Qtr 1866 6c 173 17.2.1866
---	--	--	---------------	--	---

CHART SV17

n 1881, Martha (1856) was a Servant House Maid at the Colmore Row Grand Hotel, Birmingham (Waitress in 1901?)
 Minnie possibly the 15 year old in Gloucester on 1901 census.

SHILVOCK ONE NAME STUDY

CHART SV10D: Descendants of Alfred SHILVOCK/SHILOOCK & Maria WILLOTS/WILLETTS [RCS / Ann WILLIAMS]

From CHART SV10A:

Family at Shelton Lane, Hasbury in 1881 - w/ all 8 children

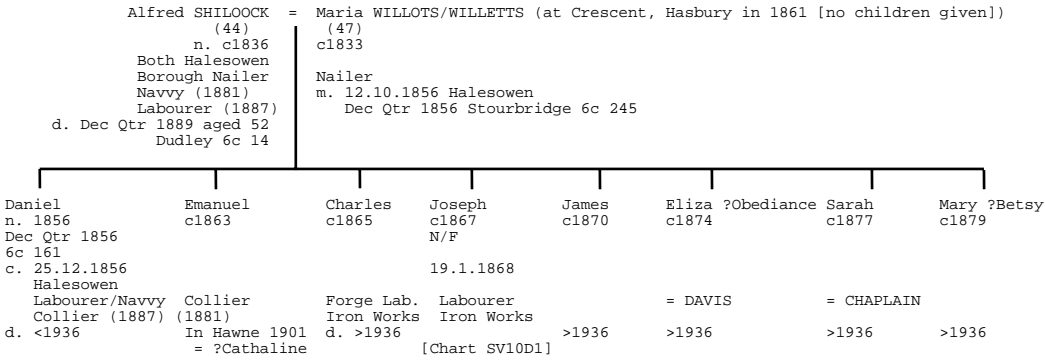

?children in 1901
 of Belle Vale, Hawne

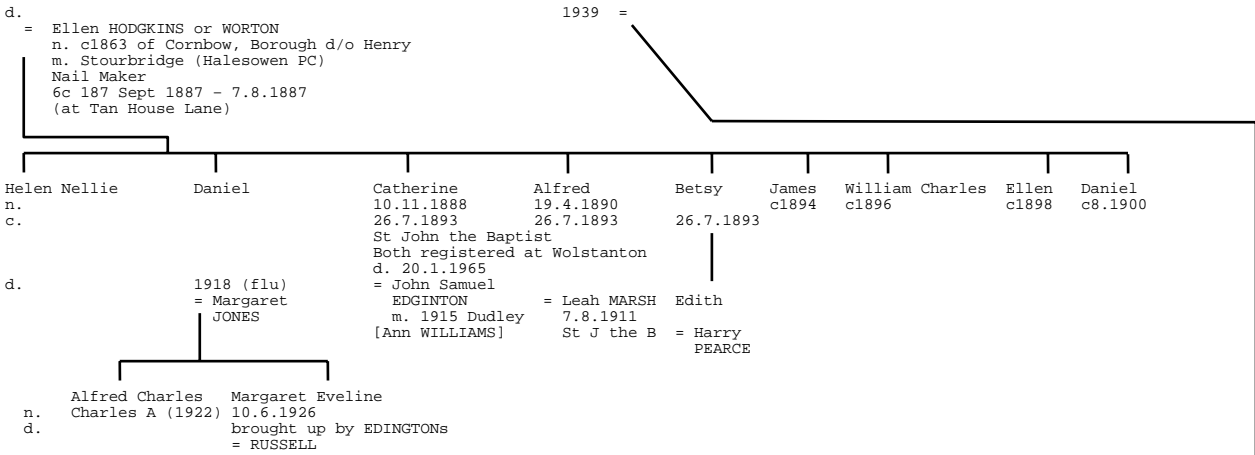

Alfred SHILVOCK c. 28.4.1839 Brierley Hill s/o Hester SHILVOCK & William INNES.
 N.B: no Hester marriages but one Esther Mar Qtr 1843 Stourbridge 18 453
 Alfred does not appear to be registered as SHILVOCK in Indices

In 1861 at 185 Crescent
 Alfred SHILVOCK, HD M 22 Nailer WOR Halesowen
 Maria wife 25 Nailer WOR Halesowen
 Daniel son 4 scholar WOR Halesowen

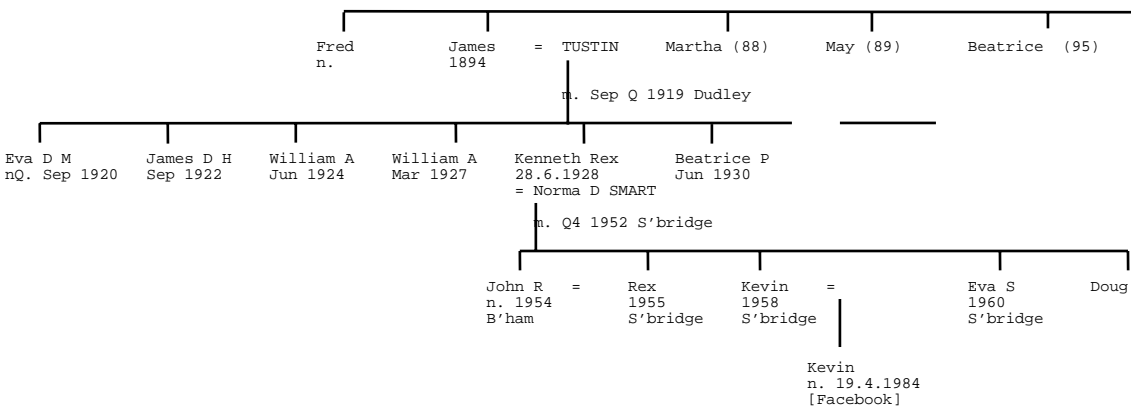

Wolstanton family - GenesReunited contact: Anthea STAPLES

SHILVOCK ONE NAME STUDY

Pearl Patricia n. June 1932	Cynthia Dorothy Sep 1934	Hugh R Jun 1937	Pauline Dec 1939	Winston G Sep 1941
--------------------------------	-----------------------------	--------------------	---------------------	-----------------------

= BARRETT

2007: John R, Keneth R & Rex at 85 BEECHER ROAD EAST, HALESOWEN, B63 2DX

Rex in Halesowen News in 2002: "Mum speaks of a life of Misery"... The case was heard at Halesowen Magistrates Court on Thursday July 18 with defendant Rex SHILVOCK ordered to be bound over to keep the peace for 12 months in ... and "Neighbour row case ends in non-event" ... Rex SHILVOCK, aged 46 (n.c.1955), of Beecher Road East, appeared on Thursday July 18, charged with harassing Julie Jones, threatening to destroy property and affray. ...

Blackcountryman Index (Black Country Society) - Article/Author/Volume/Issue/Notes/Names
- Witley Colliery / Peter Barnsley / 5 / 3 / Mining, Halesowen / Tom Newell, James Brooks, Emanuel SHILVOCK, Frank Jew

SHILVOCK ONE NAME STUDY

"Betsy Smith SHILVOCK, 73, 2746 Wall avenue, died at four-thirty a.m. today in a local hospital. She had been ill for six week [sic].

"She was born May 9, 1872 at Staffordshire, England, a daughter of Joseph and Marie Smith. Her husband, Joseph SHILVOCK, died seven years ago. She came to Ogden in 1926.

"She is survived by three daughters, Mrs. Leland Pilkington, Smithfield, Utah; Mrs. Ashton H. Cope and Mrs. Frank Jhonnton [sic], Ogden, 15 grandchildren, four great-grandchildren; one brother, Benjamin Smith, England; five sisters, Mrs. Lillian Tout, Mrs. Harry Partridge and Mrs. Ethel Glover, all of England; Mrs. Gertrude Depper, and Mrs. Ted Whitney, both of Los Angeles.

"She was a member of the L.D.S. Second Ward.

"Funeral services will be held Friday and two p.m. at the mortuary 533 Twenty-sixth. Interment, Ogden City cemetery."

Joseph SHILVOCK's obituary lists precisely when he came to the United States, 24 Dec 1924. The major port of immigration to the United States at the time was New York City (Ellis Island):

Joseph SHILVOCK sailed on the steam ship Aurania from Liverpool to New York, departing Liverpool on 6 Dec 1924 and arriving in New York on 16 Dec 1924. The obituary lists that he arrived on 24 Dec 1924, but this may have instead been the date on which he completed clearing customs at Ellis Island. He was a steerage passenger, aged 56 years. Corresponding with the fact that the obituary of Betsy Smith lists that she came to Utah in 1926, the passenger list identifies his next-of-kin in England as his wife, residing at 66 Atwood St., Hawne, Halesowen, which is where she was residing at the time of her marriage to Joseph SHILVOCK in 1917. Joseph SHILVOCK paid his own fare, and his health was described as good, with no deformities. Joseph SHILVOCK had a fresh complexion, with brown hair and grey eyes, with a tattoo on his left arm and a scar on his left leg, and he was six feet, zero inches in height. Joseph SHILVOCK's place of birth is listed as Dudley, England, and his intended final destination was Smithfield, Utah, where he intended initially to reside with his daughter "Mrs. Leland Pilkington". Joseph SHILVOCK intended to reside permanently in the United States and he intended to become a United States citizen. Joseph SHILVOCK had at least \$50 in his possession and he had never before been to the United States. Joseph SHILVOCK travelled on the Aurania with his daughter Nellie SHILVOCK and her husband Frank Johnson, and also with Ashton Harry Cope. The listing for Ashton Harry Cope reveals that his wife, Florence SHILVOCK then still resided in England, at 31 Atwood Street, Hawne, Halesowen. Nellie SHILVOCK is described in the passenger record as a domestic aged 24 years, who was born in Halesowen. Nellie SHILVOCK's health was good, she was not deformed, her height was five feet four inches, she was dark complexioned, with dark brown hair and brown eyes.

The death certificate of Joseph SHILVOCK incorrectly lists that he was a son of James SHILVOCK, as did his obituary. The informant for the obituary is identified as Leland Pilkington of Smithfield, Utah, the husband of Elsie Mary SHILVOCK. The cause of death was a cerebral haemorrhage, which was caused by hypertension and arteriosclerosis. Death occurred at his residence, 2746 Wall Avenue. Joseph SHILVOCK worked as a blacksmith for the county until June 1936, when his condition made it not possible for him to continue.

The death certificate of Betsy Smith lists that she died at the County Infirmary, where she had been for two months. The cause of death was rheumatic heart disease, contributed to by gangrene of her left foot. The informant for her certificate was her daughter Nellie SHILVOCK.

SHILVOCK ONE NAME STUDY

CHART SV11A: Descendants of William & Sarah Ann SHILVOCK of the Coventry area [BRADFORD/NZ SHILVOCKs]

From CHART SV12A:

William SHILVOCK/SHELVOCKE = (1) Sarah Ann AWCOTT/ALLCOTT (of Exhall) = (2) Ann SMITH
 n. c1838 c1839?
 d. 21.7.1896* m. 21.10.1861 (SHILVOCK) 8.8.1876 Foleshill, St Lawrence
 Sep Qtr 1896 Coventry Dec Qtr 1861 Foleshill 6d 521 Sep Qtr 1876 Foleshill 6d 614
 6d 360, aged 58 11.12.1874 1910
 Working in Cycle Factory Dec Qtr 1874 Foleshill
 6d 333, aged 35

Family living in Stoke area of Coventry

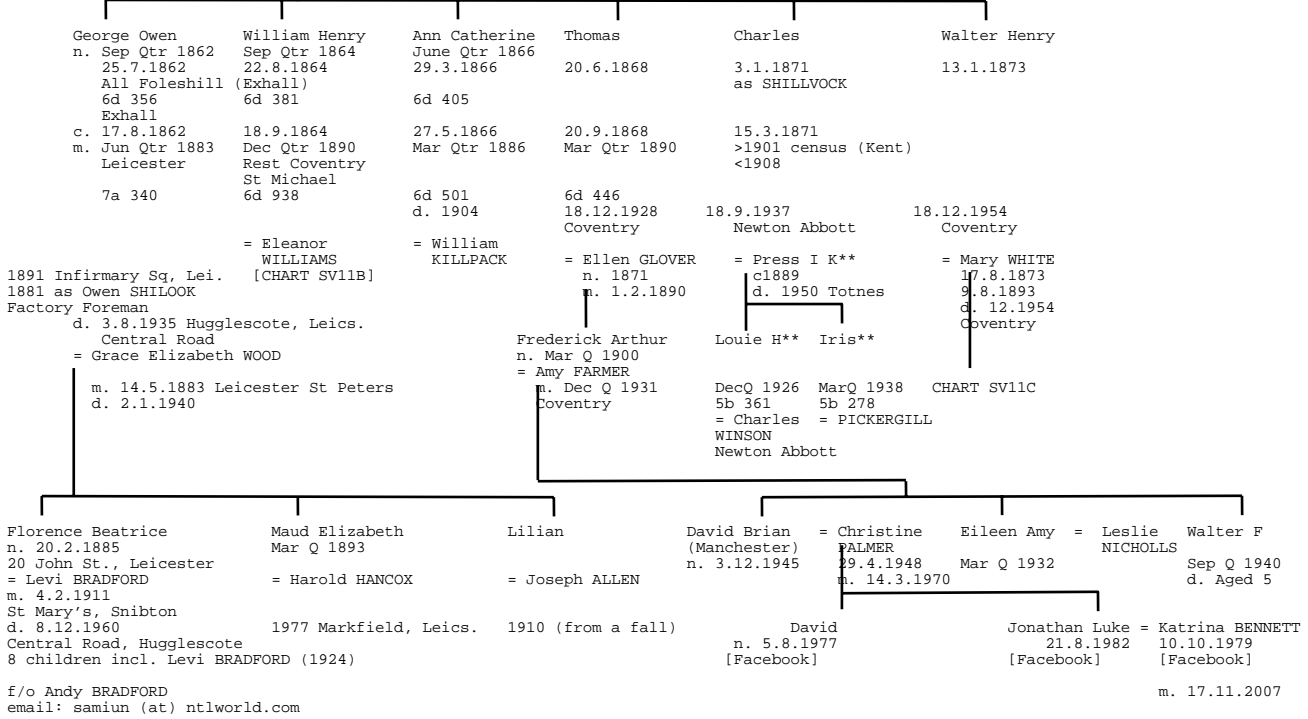

Notes

Charles moved to Torquay Road, Kingskerswell. Prior to that was single on 1901 census in Kent as SHILOOCK.
 ** Born as Press CHASE, m. 1893, Southampton = Walter BATTEN. Children Louie (1903) & Iris (1909).
 Walter's death or Charles' marriage to Press not found. Common law relationship? Children adopted as married as SHILVOCK?
 *Andy BRADFORD has copy of inquest report.
 Clues to greater family is in Entitlement List for Ethel Nellie PUGH's Estate:
 Likely descendants of Thomas and/or Charles
 8x2
 Eileen Amy NICHOLLS; David Brian SHILVOCK
 8x4
 Issue of William SHILVOCK
 8x4x2 (children of Frank SHILVOCK & Annie GALLIMORE)
 Reginald Brian SHILVOCK; Jean Mary WEASTELL
 8x4x5 (children of Walter James SHILVOCK & Amy GALLIMORE)
 Walter Edward SHILVOCK; Robert James SHILVOCK; Sylvia Dorothy COSTAIN; Margaret Ann SARTEN; Albert John SHILVOCK
 8x4 (son of Walter SHILVOCK)
 Henry SHILVOCK

SHILVOCK ONE NAME STUDY

CHART SV11B: Descendants of William Henry SHILVOCK and Eleanor WILLIAMS [BRADFORD]

From Chart SV11A:

William Henry SHILVOCK	=	Eleanor WILLIAMS
n. Sep Qtr 1864		
22.8.1864		
Foleshill (Exhall)		
6d 381		
c. 18.9.1864		
		m. Dec Qtr 1890
		Coventry St Michael
		6d 938
		8.11.1890

Ethel Nellie
n. 23.10.1896
88 Canterbury St, Coventry

d. 15.2.1980 at Walsgrave Hospital, Coventry late of 17 Parkville Highway
m. 20.7.1929
Foleshill St Paul
= David James PUGH

(no issue)

Ethel died intestate leaving a will of ca. £25,472.01, divided between 60
cousins after search. It was revealed that Eleanor WILLIAMS had six siblings, while William Henry had 5 siblings.

SHILVOCK ONE NAME STUDY

CHART SV11C: Descendants of Walter Henry SHILVOCK and Mary WHITE [NZ SHILVOCKS]

From CHART SV11A:

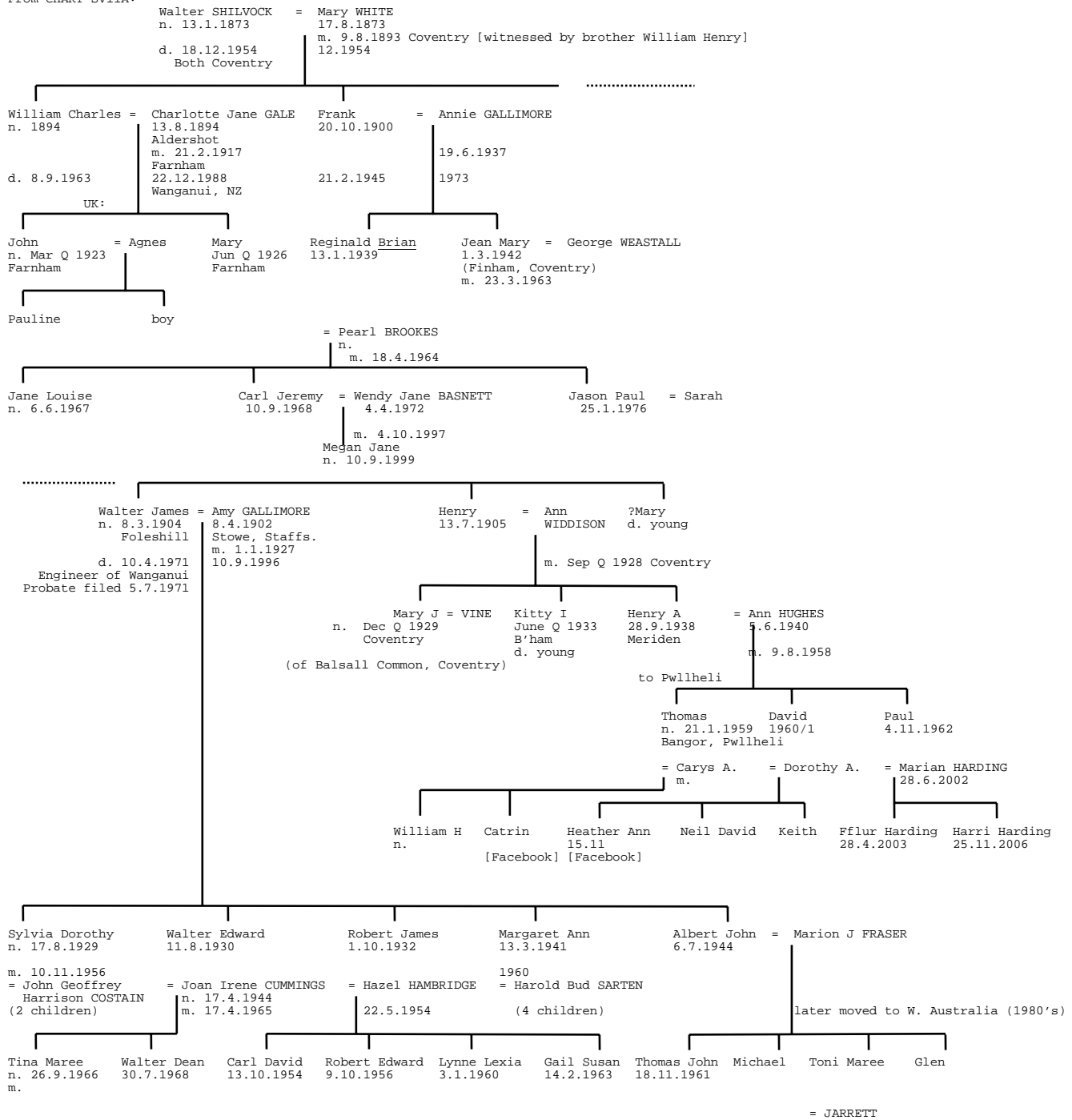

- 2007: Brian R & Pearl at 25 UNICORN LANE, COVENTRY, CV5 7LN
- 2007: Carl Jeremy & Wendy Jane at 16 OSBASTON CLOSE, COVENTRY, CV5 7NN
- 2007: Jason Paul & Sarah at 55 WESTCOTES, COVENTRY, CV4 9BB
- 2007: Paul & Marian H at GLYNCOED, PANTGLAS, GARNDOLBENMAEN, LL51 9DJ
- 2007: David, Dorothy, Heather A & Neil D at 28 MORFA'R GARREG, PWLLHELI, LL53 5AU
- 2007: Ms Ann, TY CAPEL, SARDIS, PENCAENEWYDD, PWLLHELI, LL53 6DJ
- 2007: Tom & Carys A with William H at CRYMMLWYN, Y FFOR, PWLLHELI, LL53 6NF

Kathy.Shilvock (at) tararuapho.org.nz
 kaimata (at)kaimata.schoolzone.net.nz (Tina SHILVOCK)
 GenesReunited contact: Albert John & Marion [Pauline BRADLEY]

SHILVOCK ONE NAME STUDY

Notes

Walter (1873) - Gardener and Nurseryman. Known widely in plant circles.
During WW2 many worked in the Banner Lane Standard factory in Coventry. Walter worked in the Stores, Uncle Harry in the fire brigade, and Walter James as a foreman.
Walter met Mary (a cook in a big house) when he was handsome cab coachman for a Coventry business.
Through gardening at Blenheim Palace was given fishing rights, later taken up by Walter James.

Henry - small dairy farmer in Coventry area, then went to Wales. Was in fire brigade at Standard Motors.
William Charles - mechanic/manager of garage. Bought a clothes shop in London for daughter. Son John is an electrician in Ilfracombe, Devon.
Frank & Annie - Annie cook and maid to the HILLMAN spinsters, daughters of Hillman car family. Frank - factory car machinist during war but joined family gardening afterwards.
Brian - well known bicycle rider.

L & S [9 Norway Ave., Hillbank 5112 - (08) 8287 7067]

Western Australia SHILVOCK:

Marion Joan at Warren Way Caravan Park, Manjimup 6258 [As Albert John & Marion J 6 Cain Pl. Leeming 6149 - (08) 9332 5246]

From Australia Business Directory:

ABN / Business Name / Name / Type / Location

98 145 461 971 ALBERT J & MARION J SHILVOCK: 6258 WA; WARREN WAY CARAVAN PARK (WA 6258)

57 377 507 790 SHILVOCK, MISS TONI-MAREE: 6233 WA; JARRETT, TONI MAREE

W. D. SHILVOCK, W. D. "Quantifying the physical effects of impurities in aluminium-silicon castings." Proc. IPENZ Annual Conference, Nelson, v2, 1994: 298-303 & "The effects of common melt treatments upon the final composition and properties of aluminium-silicon eutectic castings." Proc. IPENZ Annual Conference, Nelson, v2, 1994: 304-10.

SHILVOCK ONE NAME STUDY

CHART SV12A: Descendants of John & Ann SHILVOCK of Radnor & Broadway [BRADFORD / NZ SHILVOCKs]

Connected to CHART SV13D (Romsley)

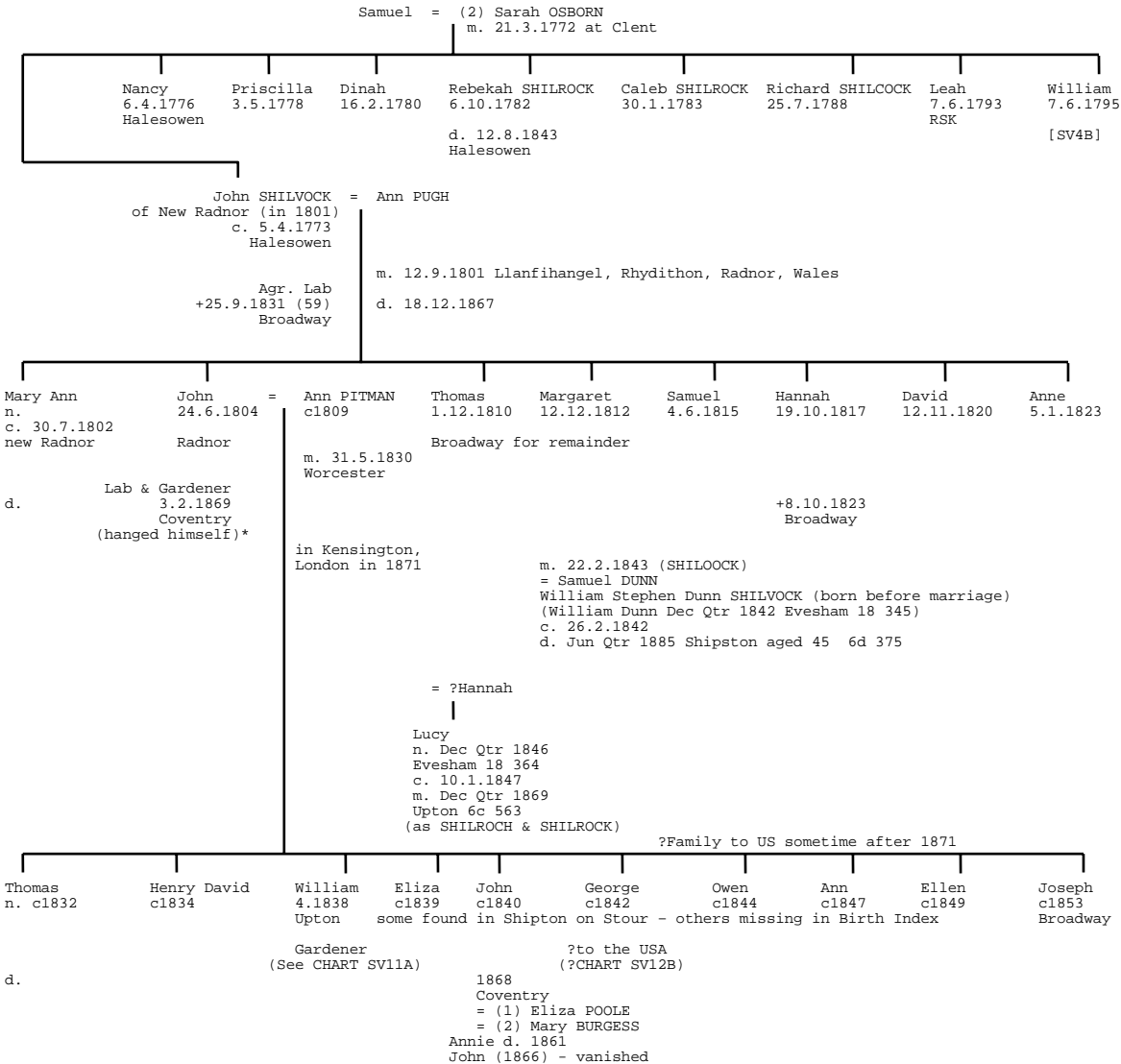

Notes

Son of John & Ann named Joseph went to Vermont c1873 and recorded on 1910 census. Found on 1861 census in Coventry. [BRADFORD]
Ann SHILVOCK nee PITMAN living in Kensington in 1871. Not found thereafter.
3.10.1892: Florence Lois SHILVOCK, daughter of Joseph SHILVOCK, Hemmingford, Quebec, died at St.Albans, VT, of bronchitis, aged 02 years 02 months. (from The Gleaner, Huntingdon, Quebec) announcements in newspaper of English speaking families.

1851 Parish of Snowhill, including Great Brockhampton, Little Brockhampton, Snowhill Hill, Small Thorns and Old Meadow:
SHILVOCK, John Servant 15 of Blockley at Farm of MEADOWS, John 28 Farmer of 210 acres of Laverton

No. 46 at Jockey Stables, Blockley, Shipston On Stour in 1851 (was in Worcs. now part of Gloucs.):

SHILVOCK, John	Head	46	Ag. Lab.	Radnorshire, Radnor (n. 1805)
Ann	Wife	42		Blockley (n. 1809) presumed m. <1834
Henry David		17	Ag. Lab.	Blockley (n. 1834)
William		13	Plough Boy	Blockley (n. 1838)
Eliza		12	Scholar	Blockley (n. 1839)
George		9	Plough Boy	Blockley (n. 1842)
Owen		7	Scholar	Blockley (n. 1844)
Ann		4		Blockley (n. 1847)
Ellen		2		Blockley (n. 1849)

In 1841 Blockley -

SHILVOCK, John	Head	35	Ag Lab	Radnor, Radnorshire
Ann	Wife	30		All Blockley
Thomas		9		Assumed to have moved on by 1851
Henry		7		
John		5		Not present in 1851. Moved on or died?
William		3		
Eliza		1		

Note: No IGI refs. for Radnorshire found (1992 edition). Radnorshire was that county bordering SW side of Salop and the west side of Herefordshire, which contained the border town of Presteigne, a local group of SHILVOCK registered to this district, the first of which was recorded in 1856. Was thought to be from Halesowen area, but perhaps this reference, if correct, suggests a family in area much earlier (but no refs. for them).

*Andy BRADFORD has newspaper article re. Inquest

William (1838) was visiting Exhall near Foleshill, Warks in 1861.

SHILVOCK ONE NAME STUDY

CHART SV12B: US Descendants of George SHILVOCK of England

From CHART SV12A:

Assumption is that George emigrated to the US to provide this US family tree in Colorado.

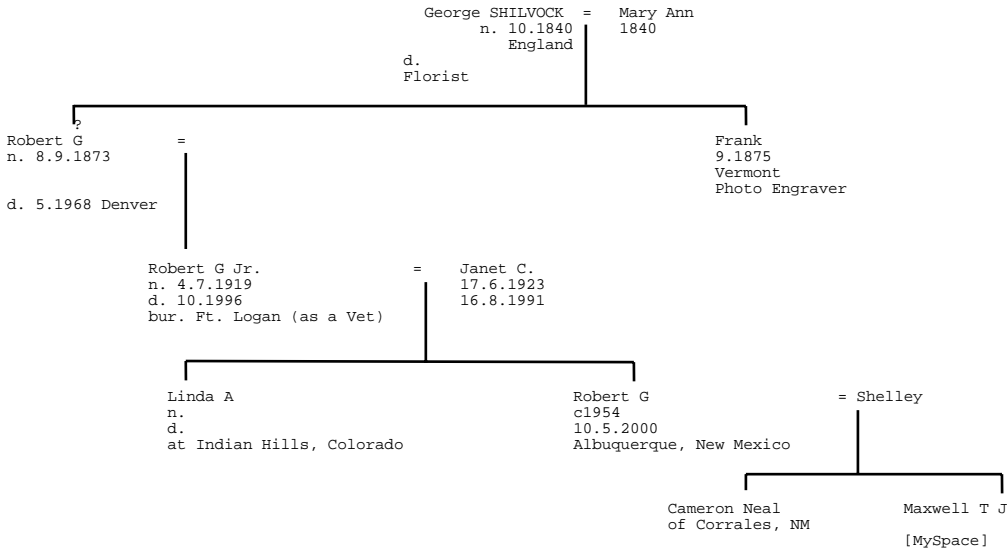

An obituary advertisements printed in the Albuquerque Journal newspaper on May 14, 2000: "Robert G. SHILVOCK, 45, a resident of Albuquerque for 16 years, died Wednesday, May 10, 2000. He is survived by his sons, Cameron Neal SHILVOCK, and Maxwell T. J. SHILVOCK; former wife, Shelley SHILVOCK, all of Corrales; and sister, Linda SHILVOCK of Denver, CO. Memorial contributions may be made to Friends in Time, 4906 Jefferson NE 87109. French Mortuary, 1111 University Blvd. NE."

Fort Logan National Cemetery
 Denver, Denver County, Colorado
 SHILVOCK, Janet C, b. 06/17/1923, d. 08/15/1991, US Coast Guard, NONE, Res: Littleton, CO, Plot: T2 0 791, bur. 10/23/1996
 SHILVOCK, Robert G Jr, b. 07/04/1919, d. 10/18/1996, US Army Air Corps, SGT, Res: Denver, CO, Plot: T2 0 791, bur. 10/23/1996

SHILVOCK ONE NAME STUDY

CHART SV13C: Descendants of Joseph SHILVOCK & Mary MILLWARD of Romsley & Halesowen

From CHART SV13A:

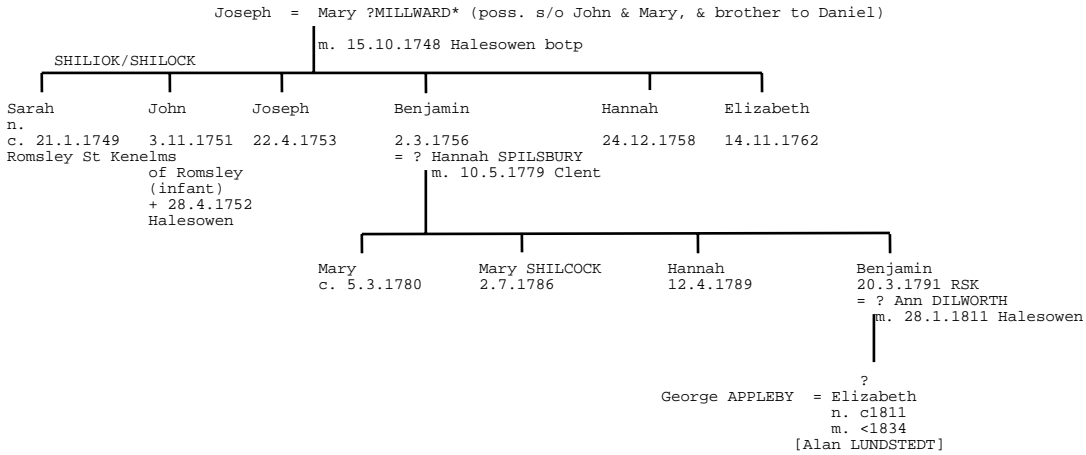

Note: Joseph & Mary MILLWARD given m. at St J the B, Halesowen 8.4.1752, so either above ref. is incorrect or there is another couple of the same name.

A Benjamin n. c1755 was +15.3.1829 aged 74 and may be the above

CHART SV13D: Descendants of Samuel SHILVOCK & First Wife Hannah DUDLEY

From CHART SV13A:

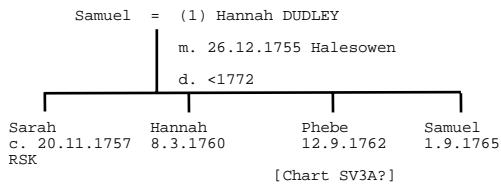

Samuel then married Sarah OSBORN in 1772
 Samuel, s/o Samuel (1766) is candidate for Samuel SHELVOKE of Willenhall (Chart SV15) but more likely head of Chart SV3A.

SHILVOCK ONE NAME STUDY

CHART SV13E: Descendants of Charles SHILVOCK & Elizabeth BURTON of Brierley Hill/Kingswinford

From CHART SV13A:

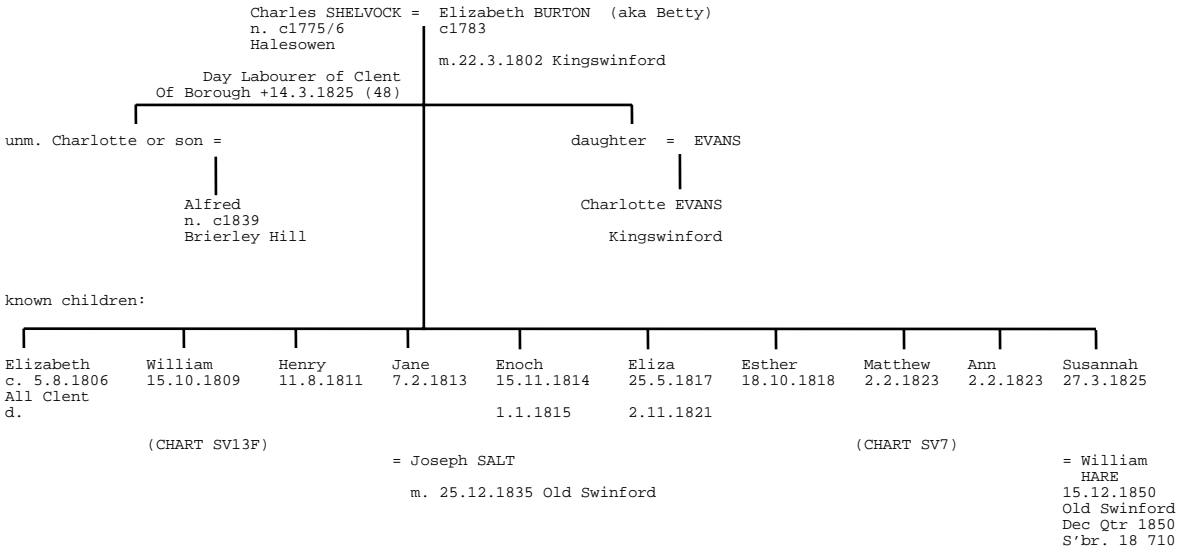

Notes

Charles (60), Agr. Lab. & Elizabeth (55) in Clent in 1841 (entry with a James (45) & Jane (40) SHILVOCK).

023 Clent, Bromsgrove in 1851				
SHILVOCK, Charles	HD	75	Ag Lab	WOR, Halesowen
Elizabeth Wife		68	WOR	
Alfred	GSon	11	Sch	WOR, Brierley Hill (n.c1839, s/o son m. <1839)
EVANS, Charlotte	GDau	7	Sch	STS, Kingswinford (n. c1843, therefore daughter m. <1843)

No EVANS marriage found.

In 1841 Clent: Alfred the grandson (2) also resident (perhaps family elsewhere as permanently resident with grandparents?)
 Matthew (20), Bricklayer, & Susan (15) present, plus Charlotte (35) I.S. (?independent). Alfred could be s/o an unmarried Charlotte, but Charlotte not known as g/o Charles & Elizabeth - ?an unlocated early child in period 1807/8

SHILVOCK ONE NAME STUDY

CHART SV13F: Descendants of William SHILVOCK & both wives Elizabeth of Hagley

Probably from CHART SV13E:

In 1841 Clent: William (30) Agr. Lab. resident at Clent House.

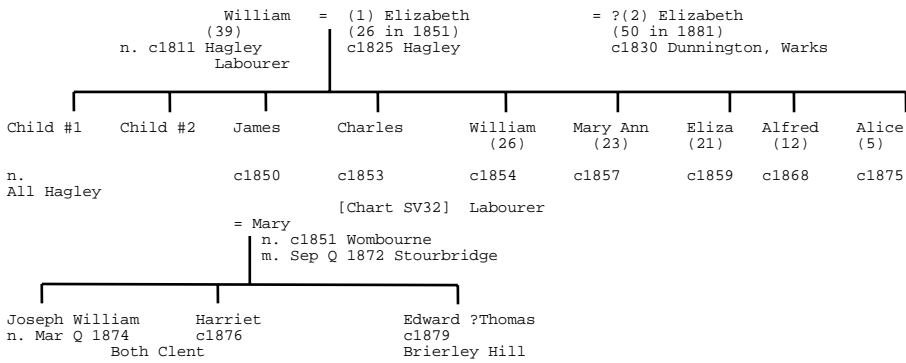

Notes:

(in Hagley in 1851 with 2 youngsters(to be identified) + 1 infant, probably James)
at 39 Hagley Village in 1861:

William SHILVOCK		HD, M,	52	Farm Lab, WOR Clent
Elizabeth	wife M	33	WAR Dunnington	
James	son	10	WOR, Hagley	
Charles	son	7	WOR Hagley	
William	son	5	WOR Hagley	
Mary A	dau	3	WOR Hagley	
Eliza	dau	2	WOR Hagley	
Thomas MORRIS	boarder	11	London	

(still in Hagley Village in 1881)

1881 Staffs Census: Kingswinford, 4 New Street				
SHELVOCK, James	Head	M 30	Horse Driver	WOR Clent (n. c1850)
SHELVOCK, Mary	Wife	M 29		STF Wombourne (m. <1873)
SHELVOCK, Joseph W	Son	7	Scholar	WOR Clent
SHELVOCK, Harriet	Dau	4		WOR Clent
SHELVOCK, Edward	Son	2		STF Brierley

SHILVOCK ONE NAME STUDY

CHART SV15: SHELVOKE of Willenhall & all C19th/C20th SHELVOKE References [Barry ABBOTTS / David BARNETT / Debbie GARVEY / GenesReunited]

Samuel SHELVOKE = Mary
 n. by 1818
 Locksmith
 d. after 1866
 Amelia SHELVOKE = Bartholomew GARVEY
 n. 22.7.1835
 Wednall, Willenhall
 c. 9.8.1835 or 27.3.1836
 St Giles, Willenhall
 m. 13.11.1866 St Thomas of Canterbury RC, Aston
 d.
 (daughter Mary (1855) son Thomas (1858) both n. Willenhall)
 26.3.1867 (33)
 Liverpool, Lancs

Amelia as SHELVOKE on all children's B. Certs. Although in a common-law marriage prior to 1866 wedding. Bartholomew was seriously ill at the time suffering from phthisis, a wasting disease of the lungs and he died the following year. They had to get married to ensure Amelia was a legal widow, i.e. they knew he was dying. Amelia SHELVOAK is mentioned in the 1851 census (District of St Giles, Willenhall) as 'visitor' at 99 Walsall Street, Willenhall with a FREEMAN family. This family was unusual in that at its head was a 'Emma' FREEMAN (15). The enumerator had remarked 'father and mother from(?) home(?)'. The others siblings are Alfred (unmarried - no age), Ann (8), & Catherine (3). At 96 Walsall Street (probably opposite), the head of family is Mary SHELVOAK, Widow (60). Living with her is Thomas BUTLER (son, unmarried, aged 32). At 97, is Joseph BUTLER and his wife, Mary, both aged 21. Above suggests Mary later married SHELVOAK as a widow and perhaps had Amelia at age 45, unless her earlier children were common-law in her maiden name. That puts her n. c1791, and possibly wife of Samuel as Amelia's father, above. Note: 1790 Samuel s/o Samuel & Sarah. Mary may be Samuel (1790) second wife after Elizabeth. 1841 census has Thomas BUTLER currycomb maker with brother Joseph 12 at Samuel Shelvoke, Walsall St

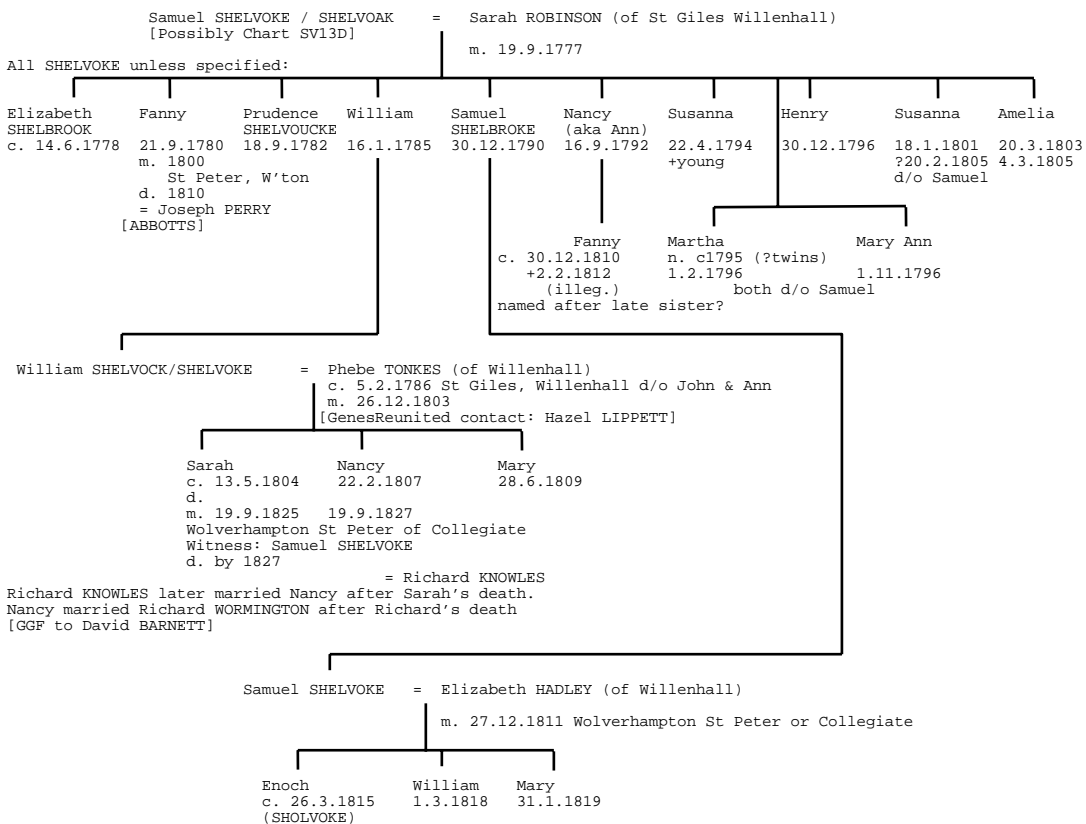

Ann SHELVOAK n. c1796 Willenhall = John ASH m. 20.2.1815 at Wolverhampton St Peters. Henry SHELVOKE was a witness. Later census information in Willenhall suggests Ann was born there. Allowing for inaccuracies of ladies ages, this is probably Ann/Nancy d/o Samuel & Sarah (above)

Phoebe SHELVEOAK = Thomas HALL 21.2.1814 Wolverhampton St Peter or Collegiate. Possibly widow of William, above. His occupation was a locksmith. On the 1851 census Phoebe is recorded as a widow with her given age as 65. In a survey taken in 1989 of gravestones still standing in Wood St. cemetery, Willenhall Thomas HALL is recorded as having died in 1849 in his 65th year and Phoebe as dying in 1863 aged 80 years. [Kath EDGERTON, NZ] Their eldest son, David was born c1814 at Willenhall, and c1832 he was transported to Tasmania on board Surrey (3) and before a couple of his youngest siblings were born. David married Ann COX in Tasmania [2xGGP of Kathryn HODGKINSON].

Prudence SHELVOOK = Edward DUDLEY 28.12.1801 Wolverhampton St Peter or Collegiate. Had 9 children. GenesReunited contact: Robert PROCTOR

GenesReunited contacts for this branch: Christopher BIRCH (Robin) [wolf38a (at) aol.com], Barry ABBOTS

SHILVOCK ONE NAME STUDY

Other Willenhall area refs.:

Henry SHELVOKE = Sarah
 (61)
 n. c1820
 Halesowen

┌───────────┴───────────┐

Fanny SHELVOKE n. c. 15.9.1843 Tettenhall, Staffs poss. m. d. ?1857	Mary Ann SHELVOKE Mar Q 1848 Wolverhampton 4.11.1855 Jun Q 1877 West Brom
--	---

possible second marriage or misname:

Henry SHELVOKE = Esther (on 1341725/3036/41/page 23)
 (61) (73)
 n. c1820 c1809
 Halesowen B'ham
 d. Q3 1895 Aston 6d 249 (75)

┌───────────┴───────────┐

(one of 2 SHELVOKE families in Warks 1881 census index at Aston)

Mary Ann SHELVOKE
 n. c1848
 m. 8.4.1872 Tettenhall, Staffs
 = Edward HINKS s/o Samuel (22)

Lucy SHELVOKE =
 poss. m. Dec Q 1871 (poss. n. Dec Q 1845 Wolverhampton)
 Wolverhampton

┌───────────┴───────────┐

Fanny Crutchley SHELVOKE
 c. 10.2.1868 Tettenhall, Staffs
 m. Jun Q 1891 Wolverhampton

Mary SHELVOKE = Joseph HODGETS 2.10.1722 Eccleshall (probably sister of Thomas SHELVOKE)

Thomas SHELVOKE = Jane WOOLRYCHE
 m. 3.7.1722 Eccleshall

┌───────────┴───────────┐

William c. 5.5.1723	Elizabeth 29.9.1726	Anne 15.3.1729	Thomas 5.11.1733	Jane 13.6.1735	Mary 21.5.1738
------------------------	------------------------	-------------------	---------------------	-------------------	-------------------

d.
 All as SHELVOKE
 All at Eccleshall

Mary d/o William & Sarah SHELVOKE c. 16.9.1798

SHILVOCK ONE NAME STUDY

CHART SV15A: A Brief History of Accles & Shelvoke Ltd.

The firm Bennett's Successors Ltd., was formed on 1.10.1903 by J G ACCLES and 6 other persons, and was funded by 6000 individuals owning a single 10 shilling share. At an Extraordinary General Meeting on 14.1.1914 at the company's registered office of the Talford Street Works, Aston, Birmingham, the company name was changed to Accles & Shelvoke Ltd., (A&S). In 1993, Eley Limited, a subsidiary of IMI plc, acquired A&S and still resides at the above address. No one of the SHELVOKE name is connected with the new company. Some archival material was transferred at the time.

It is unknown what the company produced in the early C20th, and Gordon Edwin SHELVOKE (s/o George SHELVOKE, below) in the notes he wrote after J G ACCLES death only refers to "experimental work". In the deeds of A&S a Mrs Emma SHELVOKE (historian assumes is G E's mother) leased houses in Phillip St., (nos. 49, 51 & 53) to Bennett's Successors Ltd. The deeds also mention a house in Mansfield Road, Birchfield that at one time belonged to the SHELVOKE family. The historian also listed the following facts concerning a factory in Talford Street, or possibly in Phillips Street:

1898: George SHELVOKE retired from his business at the Talford Street Works and let the Works to another company.

1896: C SHELVOKE & Co. was also working in a part of the same Works.

1891: Phillips Street Nos. 49-57 inclusive plus "shop" various tenants under the owner George SHELVOKE (Poor Rate, Vol. 2).

1890: George & James SHELVOKE, Weavers mail makers at Talford St Works (Kelley's Directory)

1876: as above (Hulley's Directory)

1833: James SHELVOKE = Catherine HOOPER or HARPER 25.12.1833 at St Paul & St Michael, Aston

The historian notes that there is only one reference for SHELVOKE in the Birmingham Central Library concerning a C SHELVOKE who died in 1955; an old boy of Bishop Vesey's School. G E SHELVOKE's son and daughter both died without issue and his son's surviving widow did not respond to the historian's letter. The Talford Street Works has two photographs; the first showing Gordon Edwin SHELVOKE on a Works outing in 1941, lighting his pipe (in the narrative he was accompanied by his second wife), and the second showing William George SHELVOKE, his son, in the 1960's.

Historical items with the SHELVOKE brand name: includes the SHELVOKE dustcart used in one of the episodes of "Dad's Army", and the SPV tender used in the TV series "London's Burning". The firm also made miniature submarines during WW2.

"As early as 1924, the Association travelled to Greece and Italy to press for improvements in animal welfare. In 1950 a member of the HAS (Humane Slaughter Assoc.) left £6,000 to help introduce humane slaughter in Canada. A joint project was set up between Miss Sidley, General Secretary of the HSA and Mr SHELVOKE, then Managing Director of Accles and SHELVOKE, a major firearms manufacturer. Slaughter demonstrations were arranged and carried out at Canada Packers by an expert slaughterman. As a result, the Canadian Parliament passed regulations enforcing the use of humane methods."

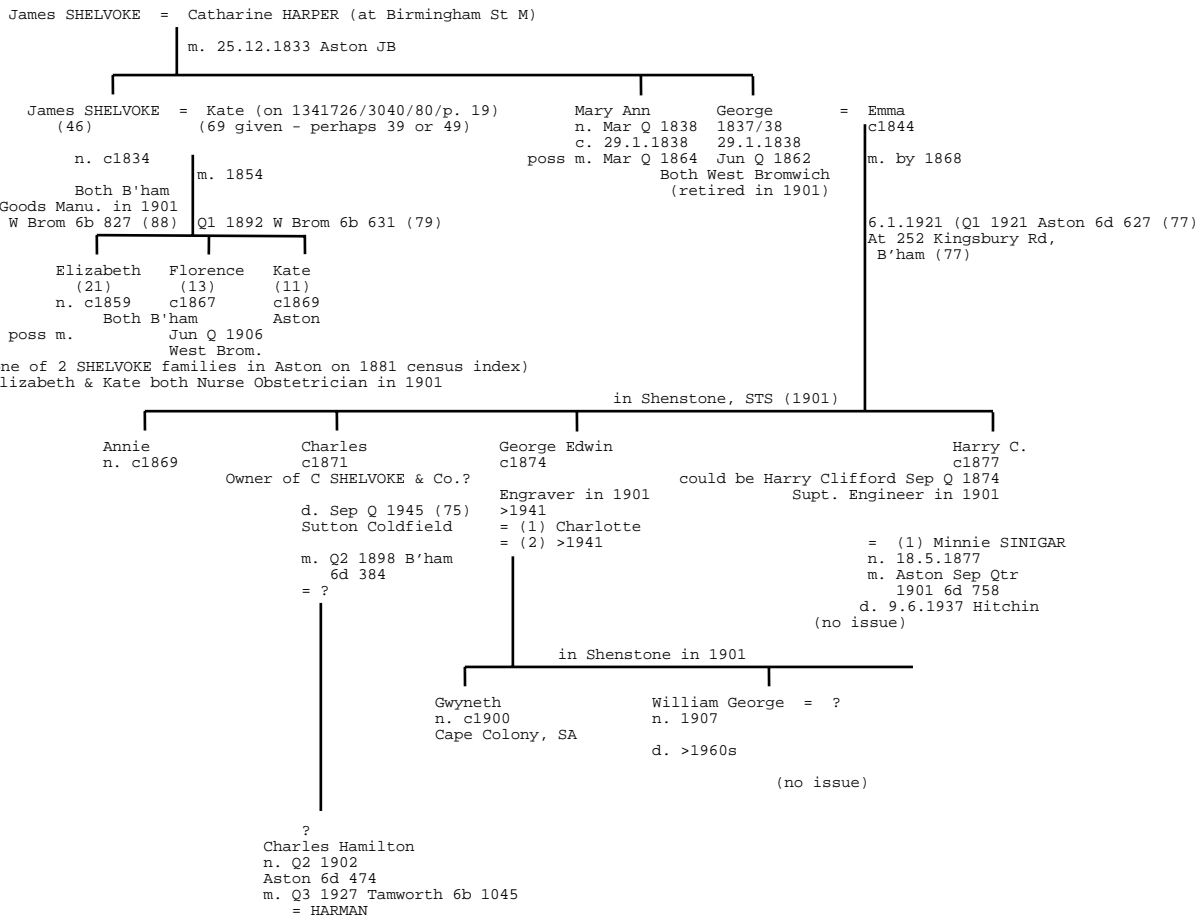

1881 Staffs census: Handsworth, 88 Trinity Rd	
SHELVOKE, George	Head M 43 Mans Mail Man+ WAR Birmingham (n. c1837)
SHELVOKE, Emma	Wife M 36 WAR Birmingham (m. <1868)
SHELVOKE, Annie	Dau 12 Scholar WAR Birmingham (possibly m. Dec Q 1894 West Bromwich)
SHELVOKE, Charles	Son 10 Scholar WAR Birmingham (possibly m. Jun Q 1898 B'ham)
SHELVOKE, Geo. Ed	Son 6 Scholar WAR Aston
SHELVOKE, Harry	Son 3 WAR Aston (possibly m. Sep Q 1901 Aston)

Emma SHELVOKE died 6.1.1921 suddenly 252 Kingsbury Rd, aged 77 (Birmingham Daily Gazette)
 John SHELVOKE: TINEY, Eliza; of 51 Edwardes Street, Balsall Heath, Worcestershire, spinster, died 11 Jan 1893, Probate London 20 Feb
 to John SHELVOKE, gentleman [vctinney(at)dcn.davis.ca.us]
 Maria SHELVOKE d/o James = Charles ROCK s/o Noah m. 26.10.1845 Sedgley, STS

London Gazette #34730 - 10th Nov, 1939:

JAMES GEORGE ACCLES, Deceased.

NOTICE is hereby given pursuant to the Trustee Act, 1925, that all persons having any claims or demands upon or against the estate of James George

SHILVOCK ONE NAME STUDY

CHART SV16: Descendants of Thomas SHILVOCK & Anne/Annie LEES of Halesowen [Angela J. SHILVOCK]

Possible parents of Thomas (Births):

Q1 1864 Stourbridge 6c 190 s/o Edward & Amelia ANDREW [Chart SV3E] - most likely based on being a Halesowen rather than Clent family
 Q3 1865 Bromsgrove 6c 375 s/o Thomas & Maria SMITH [Chart SV5A3] - Clent family

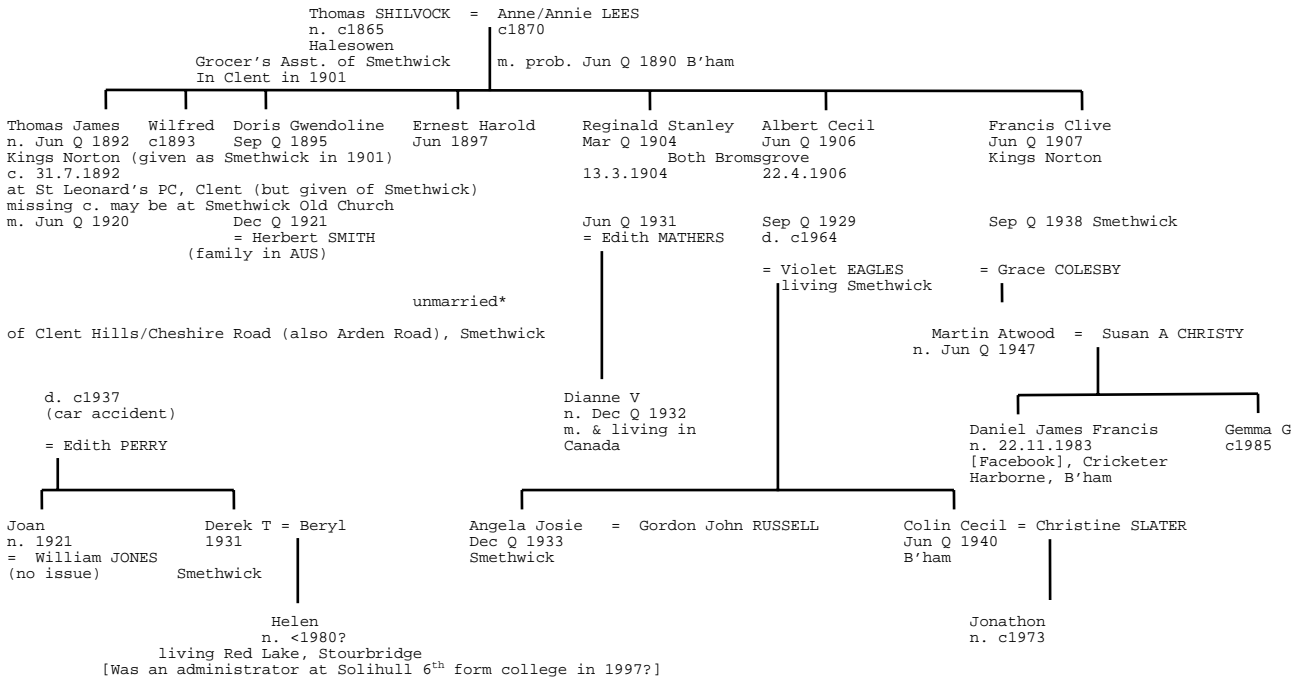

Thomas James was born in a cottage behind the bakery opposite The Woodman pub d. on Hagley bypass c1937

London Gazette 18th July 1919 (#31463) - Cadets granted Hon. Commissions as 2nd Lts.:

310290 Thomas James SHILVOCK on 2nd May 1919

* Records shows an Ernest H married Jun Q 1924 at Kings Norton = HINE. GenesReunited contact: Robert HINE

2007: Martin & Susan, with Daniel & Gemma at 23 CROFTDOWN ROAD, BIRMINGHAM, B17 8RA

SHILVOCK ONE NAME STUDY

MILLENNIUM PROJECT - Modern Unlinked SHILVOCK Trees

CHART SV18: Realtions of Alfred Cyril SHILVOCK of Stourbridge

Based on an Obituary from "Express & Star" in 1983 - "Mr A. C. SHILVOCK, Stourbridge"

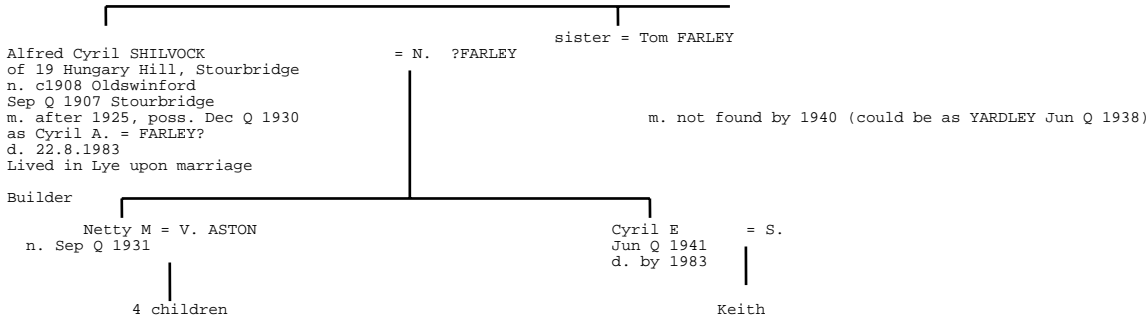

Express and Star Obituary 1983 - Mr A C SHILVOCK, Stourbridge - Mr. Alfred Cyril SHILVOCK aged 75 passed away on August 22 following a long illness. His home was 19 Hungary Hill, Stourbridge where had lived for 32 years. He was born in Oldswinford where he spent his early life, moving into Lye on the occasion of his marriage. He was a builder by trade and worked for several local firms. During the second world war he worked on the Mulberry Harbours in preparation for the invasion of France. He was well known, and respected throughout the local area. He leaves his wife, daughter and five grand-children.

The mourners were Mrs. N.SHILVOCK (wife) Mrs. N Aston, Mr. V Aston (daughter and son-in-law) Mark, Peter, Andrew, Ann Aston and Keith SHILVOCK (grandchildren) etc.

CHART SV19: Descendants of William SHILVOCK of Lozells, Birmingham

SHILVOCK, Edna D. 2, Belwell Drive, Sutton Coldfield, West Midlands B74 4AH
 SHILVOCK, Ashleigh K.
 0121 308 4401

IF Bromsgrove reference correct for Joseph William, then likely tree is head by James & Mary

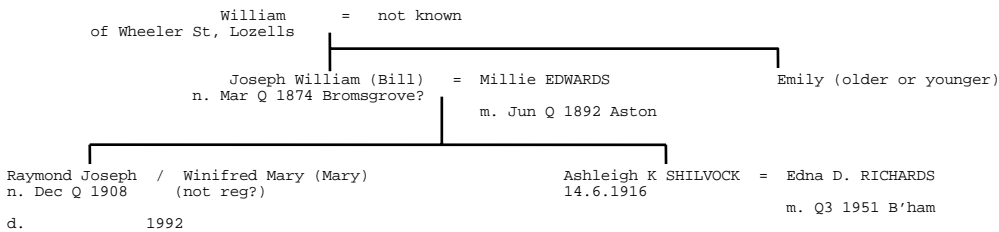

Raymond was one of triplets (one stillborn). He died aged 2 ½
 Bill was a draughtsman and helped design the Lewis Gun at BSA.

CHART SV20: Descendants of William Charles SHILVOCK of Hawne

Doris K SHILVOCK of 113 Alexandra Road, Halesowen, B63 4BL - Tel: 0121 550 2844

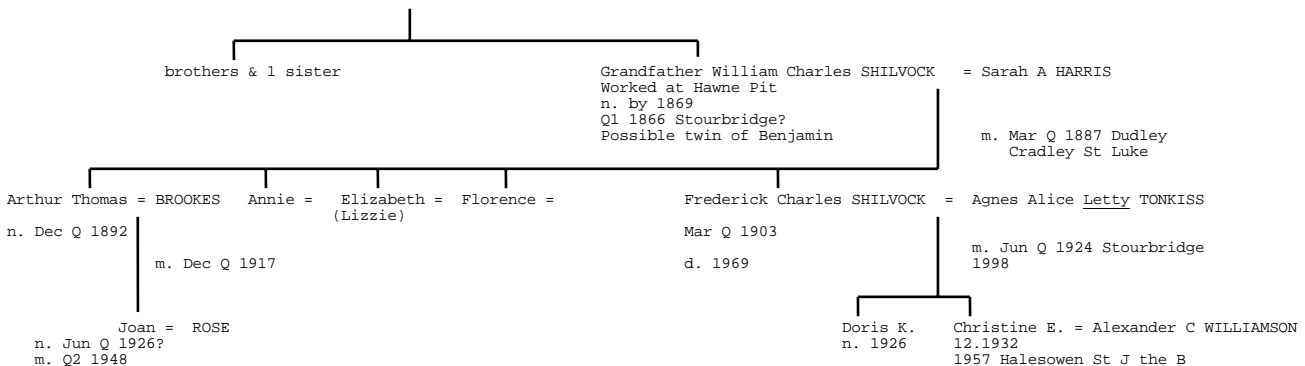

SHILVOCK ONE NAME STUDY

CHART SV21: Descendants of Joseph & Elizabeth SHILVOCK of Hasbury

margaret(at)neyrod.freereserve.co.uk

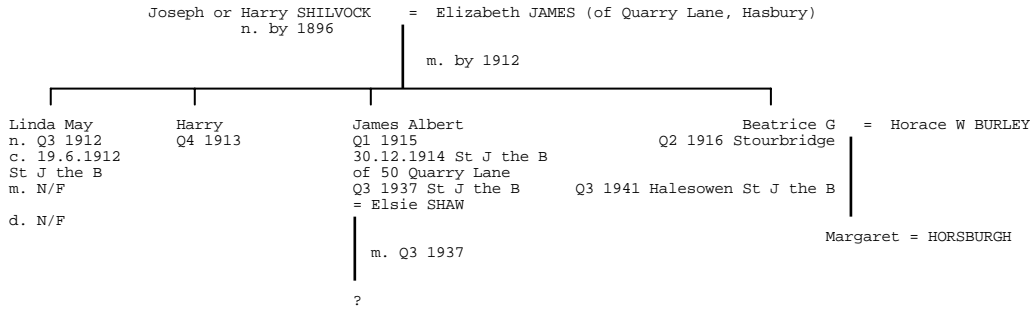
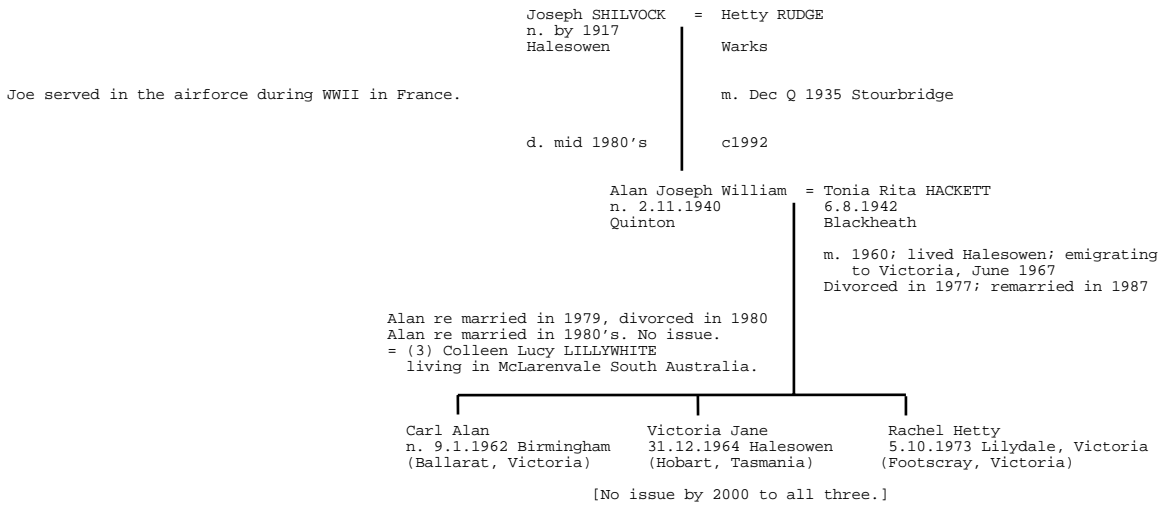

CHART SV22: Descendants of Joseph SHILVOCK & Hetty RUDGE [Vicky SHILVOCK]



SHILVOCK:
Alan Joseph William & Colleen Lucy at 11 Palomina Ave., McLaren Vale 5171 - (08) 8323 8054

Tasmania
SHILVOCK:
Victoria Jane at Hermons Rd, Geeveston 7116

Victoria
SHILVOCK:
Carl Alan at Eureka Caravan Park, Stawell St, Ballarat 3350
Rachel Hetty at 5/7 Muir St, Frankston 3199 [4 Station Rd Footscray 3011 - (03) 9687 7578]

From Australia Business Directory:
ABN / Business Name / Name / Type / Location
31 538 327 746 COLLEEN L SHILVOCK & ANN BRENNAN: 5035 SA; NADA'S KIOSK (SA 5035)
13 709 902 767 SHILVOCK, MR JAMES LEIGH: 2230 NSW; CONNECTIONS CONTRACTING (NSW 2230)

CHART SV23: Unknown SHILVOCK - ROWE Connection

Dougie ROWE of 151 Grange Court, Dale Street, Graysley, Wolverhampton, WV3 0PL:
Unknown connection but father named Leonard Frederick SHILVOCK ROWE n. c1899 d. 1949 (50)

SHILVOCK ONE NAME STUDY

[assumed it should be R J SHILVOCK]

- Phil G [196 Kitchener Road, Kedron 4031 - (07) 3359-5659] (RFL player)
Phil plays for the South Queensland Crushers - he played centre and wing for Logan City Scorpions.
2004 Update: plays for the Redcliffe Dolphins:
 Nickname: Vocky
 Date of Birth 31.8.1978
 Birthplace: Emerald (near Capella)
 Position: Wing
 Age started playing: 10
 First Team: Capella Road Runners
 School: Capella State School
- Steven G [200 Appleby Rd, Stafford Heights 4053 - (07) 3359-0461] (brother of above)
Steve plays for North Devils (Queensland RL)
Other Facebook SHILVOCKs - Kim Turner SHILVOCK, Phil SHILVOCK
- **Ursula** SHILVOCK studying B. App Science Animal Studies at Queensland University, Rockhampton.
- Tammy Naurelle & Vincent Robert at Langton St, Capella 4702 [Retro Rd Capella 4702 - (07) 4984 9408; Mobile Service 0417 191] - resident in 2006
Australia Business Directory: 44 582 189 747 V R & T N SHILVOCK / VINCENT R & TAMMY N SHILVOCK: 4702 QLD
Register of Approved Occupational Clothing: VR & TN SHILVOCK, CW6024, QLD
- Mrs Beth SHILVOCK noted as highly active in a number of areas in Capella (Agricultural & Pastoral Show, School, Parish Church Secretary (St. Joseph), Rugby Union). Teacher aide at Capella school.
- Noted at a Sabbath Service in Clermont, QLD; Brenda SHILVOCK and her four children, Jessie, James, Ben and Caitlyn;

Queensland SHILVOCKs to be connected

- Juanita Gayl & Lyle Rennie at Peak Downs St, Capella 4702
Australia Business Directory: 43 376 146 204 SHILVOCK, MR LYLE RENNIE: 4702 QLD
- Ellen Marie (Eileen Marie) at 29 King St, Urangan 4655 [33 Jensen Drive Pialba 4655 - (07) 4124 0573]
d. 14.1.2001 (87) at Hervey Bay
- Judy Ann at M/c 4259 Goanna Flats Rd, Rubyvale 4702
- Kathy Joy at Lt15WD/1695 Natural Bridge Rd, Natural Bridge 4211 - (07) 5533 6159
Kathy SHILVOCK (DEM Party) Queensland
- SHILVOCK daughter **Hayley**, a pupil at Capella School in 2001.
- Legal death of Brigette Anna SHILVOCK 26.5.2006, late of Bligh Park (not age given)
- South Australia SHILVOCK: L & S [9 Norway Ave., Hillbank 5112 - (08) 8287 7067] - unknown

SHILVOCK ONE NAME STUDY

Kenneth William, Kerri Lee & Shirley Dawn (Mrs) at 123 Walker St, Maryborough 4650 - (07) 4121 2051
KW (Bill) d. 15.4.2001 (66) of "Timbotoe", Tairo.
Australia Business Directory: 75 043 391 769 SHILVOCK, MRS SHIRLEY DAWN: 4650 QLD

Notes

Court extract: Shilvock, Kerri Lee, 26 July 1999, Maryborough District Court, Botting DCJ

- Dangerous driving causing death with circumstance of aggravation
- Guilty plea
- No criminal history, age 27

Circumstances of offence:

- Shilvock had been taking prescribed drugs for many years. The drug levels in her body were in accordance with taking of prescribed medication but also with long term use.
- Offence occurred when she was driving over a 20km distance erratically but apparently under the speed limit - including at times going to the other side of the road and driving whilst aware that she was fatigued
- She ran into a pushbike travelling in the same direction as her
- Rider of pushbike died a few hours later
- Found not to be "momentary inattention" but a "course of driving that was clearly dangerous"

Other factors:

- Shilvock suffered from depression, bi-polar disorder and schizophrenia
- She was not employed but had good work history as an enrolled nurse
- She was not aware of her situation in regard to driving while on medication
- She had many problems in her life and some of these were ongoing
- She had voluntarily surrendered her licence and said that she intends to not drive again
- His Honour observed that this was not a case where recreational drugs were used

Shilvock showed remorse, pleaded guilty and co-operated with authorities
Sentence: 2 years imprisonment

SHILVOCK ONE NAME STUDY

CHART SV29: Kimberley SHILVOCK Family, Ontario, Canada

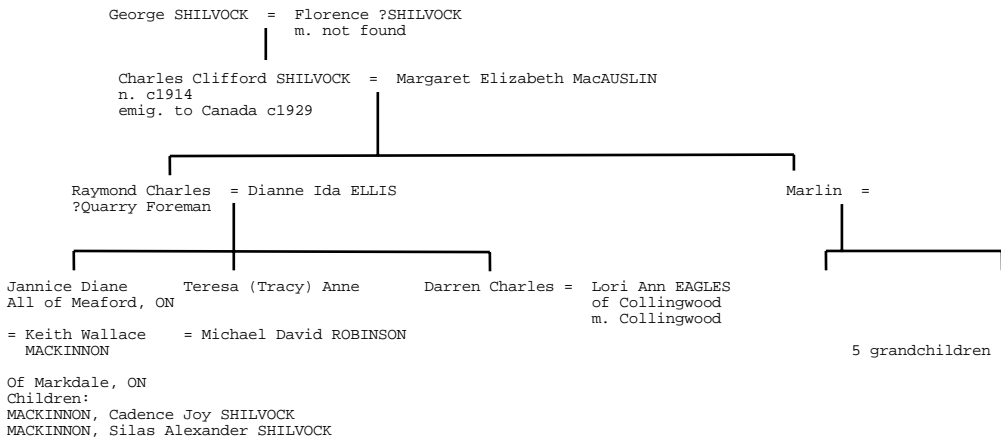

'SHILVOCK Road' in Kimberly, Ontario; the town lies just south of Georgian Bay on Lake Huron approximately 150 miles from where the majority of the SHILVOCK's settled in the Niagara region of Ontario.
SHILVOCK family farm which is on the SHILVOCK Side road in Kimberley, Ontario, Canada. The farm has been in the family for three generations.,
Raymond SHILVOCK: at 519-599-3005 or at their cottage at 519-924-3414.
Son Darren SHILVOCK: at 519-599-5626.

GenesReunited contact: Lynn ROBINSON-LITTLE
Clifford SHILVOCK (1916) who be her my uncle emigrated to Canada in the 20s.He went there with the church along with his friend Jim SHEPHERD. He got killed c1956 when his tractor overturned.

SHILVOCK ONE NAME STUDY

CHART SV30: Ancestry of Kelvin David SHILVOCK, Minister of Kidderminster

Unknown origins - perhaps William s/o Isaac married Ann RUDGE (SV3C) but no proven link:

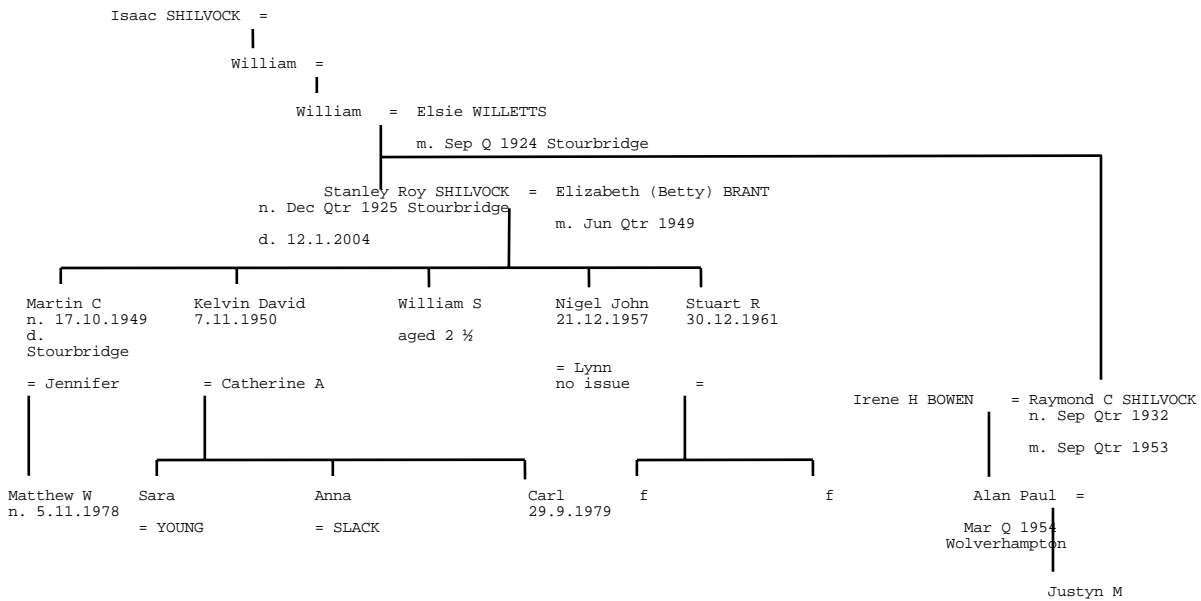

Kelvin has a family Bible handed down from Isaac SHILVOCK presented to him in 1861 by the Stewponey Assoc. 'for the improvement of the condition of the labouring classes' handed down to his son William in 1882 and to his grandson, [Kelvin's grandfather] in 1924.

- 2007: Kelvin & Catherine A. at 99 COLLEGE ROAD, MARGATE, CT9 4AA
- 2007: Martin & Jennifer, with Matthew at 104 STOURBRIDGE ROAD, HALESOWEN, B63 3UN
- 2007: Nigel John & Lynn at 41 BROMPTON DRIVE, BRIERLEY HILL, DY5 3NZ
- 2007: Alan Paul & Justyn at 14 THORNHILL ROAD, HALESOWEN, B63 1AU
- 2007: Justyn M also given at 27 BELGRAVE ROAD, HALESOWEN, B62 9EY
- 2007: probably Raymond C at 19 HIGH FARM ROAD, HASBURY, HALESOWEN, B63 4TQ

SHILVOCK ONE NAME STUDY

CHART SV31: Californian SHILVOCKs [Darrin]

From CHART SV10B12:

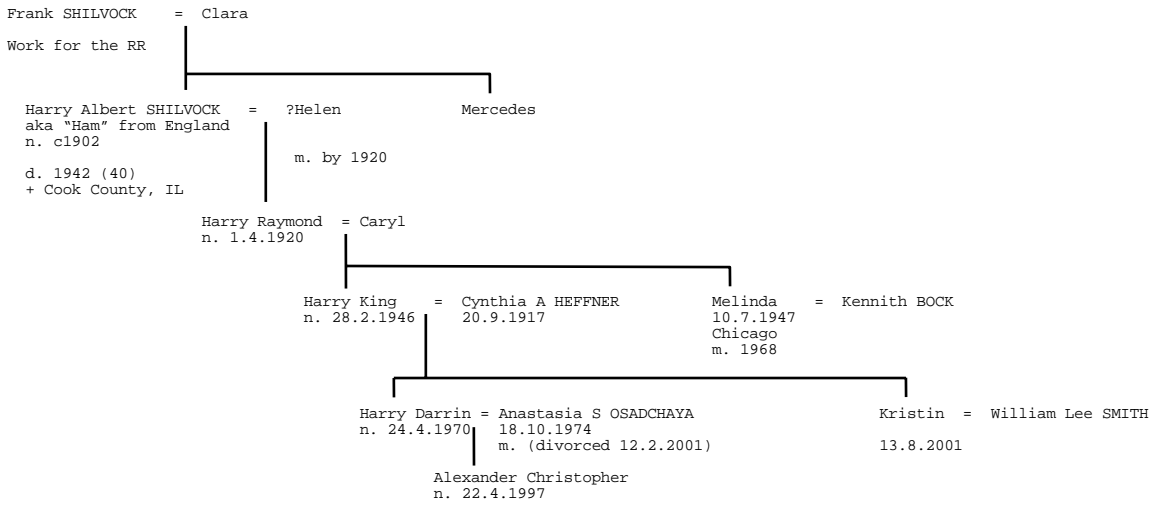

Family moved from Chicago to Michigan area, then to California in 1956

Harry D is telephone reference for Escondido & later Oceanside
 Harry K is at San Juan Capistrano
 Harry R & Caryl at Joshua Tree
 Kristin at San Diego

SHELVOCK, Helen Mae (interred in EVANS family plot): Apr 2, 1901 - Mar 26, 1975 at Green Grove Cemetery
 Greengrove Ave. Keyport, NJ (See Photo on shelvockpics.html). Could this be Helen above?

Strock Consultants was formed in June 1990 by Eddy STRIDE and Harry SHILVOCK, both of whom have had extensive experience in all areas of Industrial
 Engineering: Strock Consultants, Inc. P.O. Box 370, Somis, CA 93066 (by Harry D, above?)

CHART SV32: Hagley Ancestry of Ges SHILVOCK

From Chart SV13F:

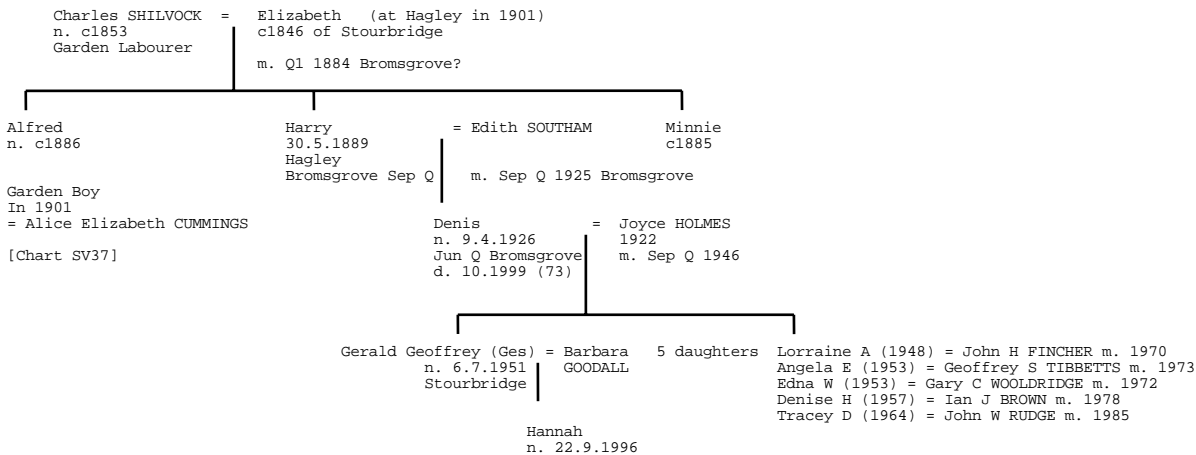

Family bible back to 1853
 Ges now in Huish Episcopi, SOM, UK
 GenesReunited contact: Ges (Gerald Geoffrey SHILVOCK)

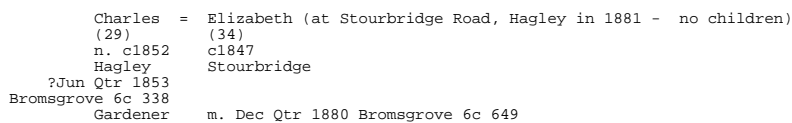

SHILVOCK ONE NAME STUDY

CHART SV33: Descendants of Jesse SHILVOCK & Jane GREATREX of Stourbridge [Julian SHILVOCK]

Possibly from Chart SV5B1 (John & Elizabeth) or SV5C (John E & Sarah):

Children of one of two Jesse SHILVOCK:

Siblings: Eliza, Elizabeth, George, Bill (?William), Harry, Herbert
Parents unknown

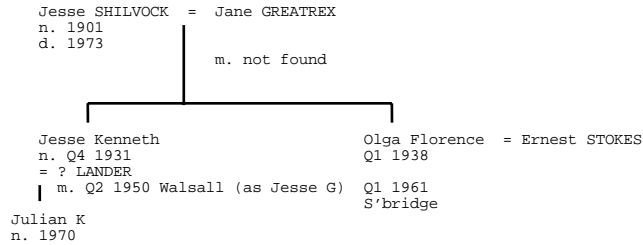

Possible child: Julie n. Q1 1957 Walsall to SHILVOCK=LANDER
A Kenneth J also married in 1964 Dudley to Jean BOWATER (possible different person or 2nd marriage)

2007: Ms Heather, Julian K & Kenneth J at 45 CLYDE TERRACE, SPENNYMOOR, DL16 7SG

CHART SV34: Leamington SHILVOCK Family

From 1901 census and Chart SV9D:

Rowland - s/o Eli & Fanny PARTRIDGE

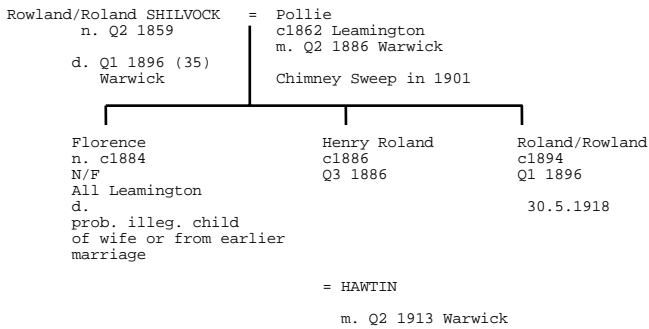

Rowland - WWI - award Military Medal. Private in 10th Bn., Royal Warwickshire Regiment.

SHILVOCK ONE NAME STUDY

CHART SV35: Oldswinford SHILVOCK Family of Heath Lane

Family not apparent on 1901 census.

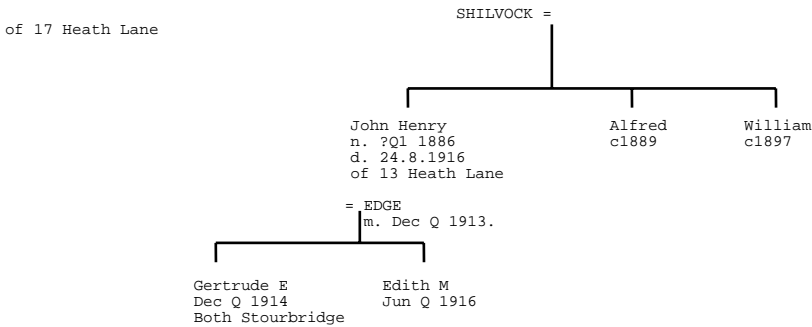

L/CPL JOHN SHILVOCK - 24 AUGUST 1916

3RD BN - THE WORCESTERSHIRE REGIMENT

John SHILVOCK lived at 13 Heath Lane, Oldswinford, and was married with two children. His parents lived at 17 Heath Lane and he attended Oldswinford C. of E. School. Before enlisting as a volunteer he was employed by Mr A. Guest. He had signed up in August 1915 and was then posted to the 3rd Battalion of the Worcesters. He went out to France in March 1916 and was present in the successful struggle of the 25th Division to gain Vimy Ridge in June. After a period of rest and re-training it joined 4th Army for the forthcoming battle of the Somme.

The Worcesters remained in reserve for the famous 'first day of the Somme'. On 3rd July they moved into Aveluy Wood and received orders to attack the notorious Leipzig Salient, a complex of German trenches protecting the approaches to the village of Thiepval. The Worcesters were ordered to fight their way up the steep wooded slopes of the river Ancre under intense artillery and heavy machine gun fire. They did not quite succeed, but held on for four days until 8th July. Although losses were heavy, the next day they were ordered to help in the critical battle around the nearby village of Ovillers. For five days the battalion was in the line and a local man, Lt J. Mould of Wordsley, was awarded the DSO for his leadership.

After these efforts the 25th Division retired to a quieter sector, but only until 18th August. Then it returned to the Leipzig Salient, the German strongpoint which had resisted all attacks since 1 July. In very hot weather on 24th August the Worcesters and Wiltshires attacked under a devastating barrage and seized Lemberg trench. They then resisted shelling, bombing and counter-attack for two days and managed to hold the valuable territory they had gained. But the costs had been high. L/Cpl SHILVOCK together with 37 other men were killed, with 15 missing and 173 wounded. Also killed was Lt/Col W. Gibbs, commanding the battalion, whose father had been Rector of Hagley and who is commemorated by a memorial window in St. John's church.

John SHILVOCK had come through some of the worst fighting on the Somme, but was killed when a shell landed in his trench. His name is commemorated on the Thiepval Memorial, which was built near the site of the Leipzig Salient where he died. John SHILVOCK's death left a widow and two young children. He had two brothers who served in the war and both are recorded on the St. Mary's memorial of those who served their country. Pte Alfred SHILVOCK, aged 27 in 1916, and Pte William SHILVOCK, aged 19 in 1916, of 17 Heath Lane were both in the Army Service Corps. [Source: County Express 22 September 1916]

CHART SV36: Leicester Farming SHILVOCKS [Steven SHILVOCK - Facebook]

Next known marriage is Leonard Cavendish SHILVOCK = Adelaide B PARTRIDGE in Q4 1909 Halesowen. Child: Ruby I born in 1912 S'bridge. Then big jump to Leicester if this family. Also other Leicester families in late C19th.

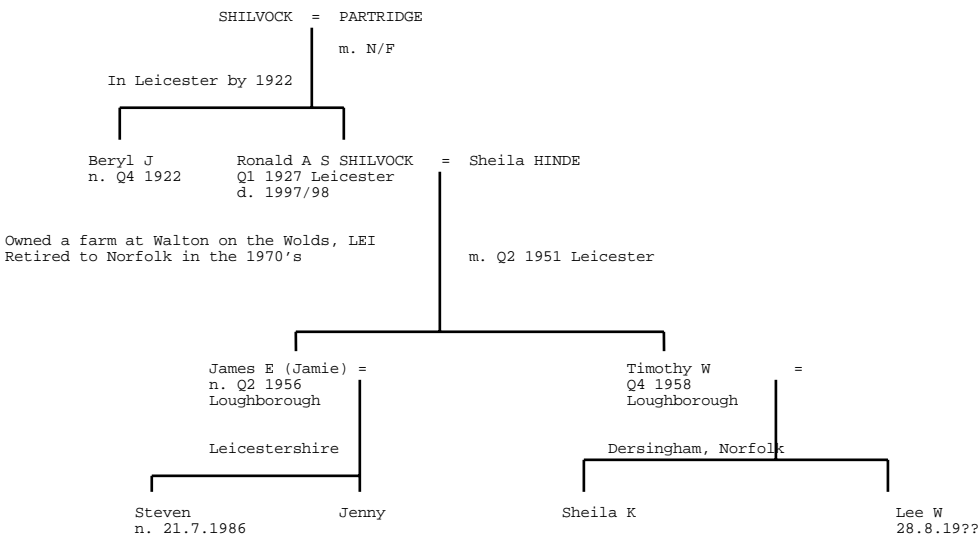

2007: Lee W at 10 MANOR ROAD, DERSINGHAM, KING'S LYNN, PE31 6LD
 2007: Ms Sheila K at 77 MOUNTBATTEN ROAD, DERSINGHAM, KING'S LYNN, PE31 6YE

SHILVOCK ONE NAME STUDY

CHART SV37: Bromsgrove ancestry of Olivia SHILVOCK and James & Helen SHILVOCK [Facebook]

From Chart SV32:

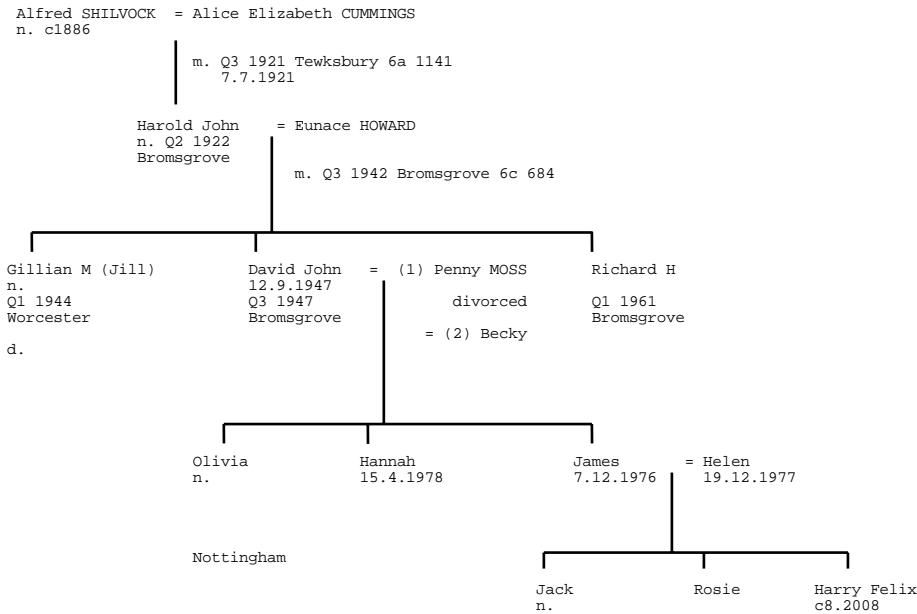

2007: Olivia at 82 TRENT ROAD, NOTTINGHAM, NG2 4FB

CHART SV38: Bromsgrove family of Lynn SHILVOCK [Facebook]

Lye area

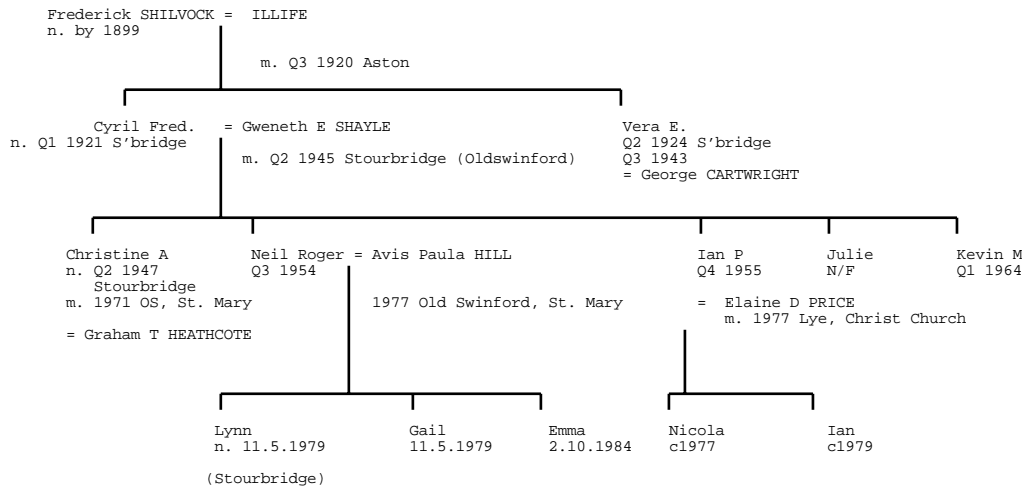

2007: Ms Emma & Ms Lynn at 17 CHURCHWARD CLOSE, STOURBRIDGE, DY8 4HX
 2007: Neil Roger at 8 SMALLSHIRE WAY, STOURBRIDGE, DY8 4XQ

SHILVOCK ONE NAME STUDY

CHART SV39: Wollaston, Stourbridge family of Philip SHILVOCK [Facebook]

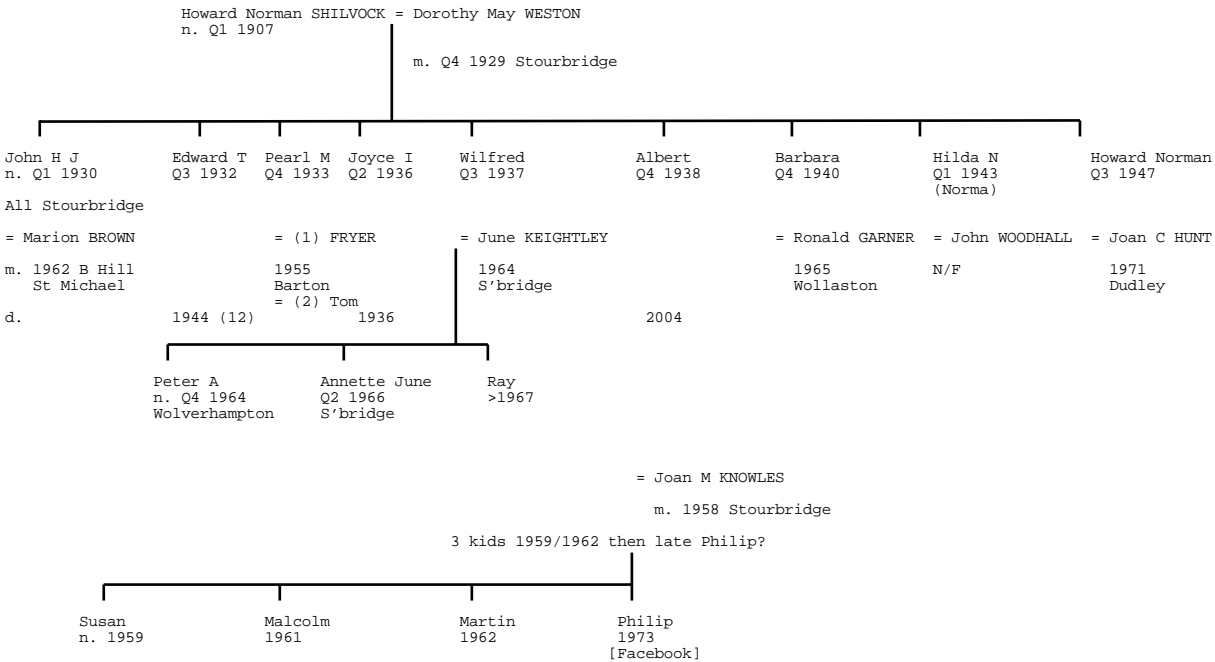

Martin SHILVOCK, aged 40, of Gibbs Road, Lye, was sentenced to prison for 22-weeks after admitting driving without a licence or insurance (Stourbridge News - 16.1.2003, page 9)

CHART SV40: Halesowen Ancestry of Daniel SHILVOCK [Facebook]

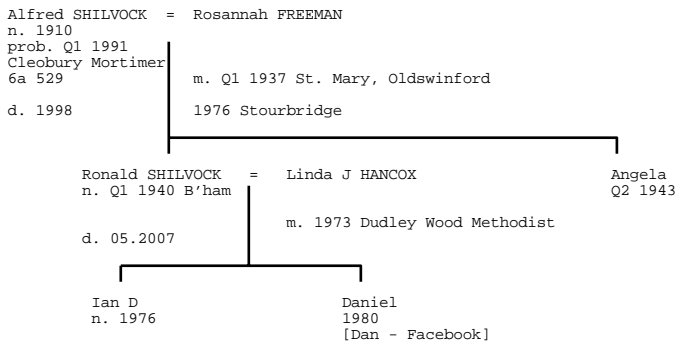

In 2007 Ian D, Linda J, Daniel & Ronald at 15 DUNSTALL ROAD, HALESOWEN, B63 1BB

Possible Cleobury family (on 4 birth refs):

Albert Edward (Q4 1907) - no mother given
 Alfred (Q1 1911) - no mother given
 George H (Q4 1914) - mother GRAY
 John (Q1 1917) - mother GRAY
 Parents could be Albert SHILVOCK = Elizabeth GRAY at Quarry Bank Christ Church Q2 1898

SHILVOCK ONE NAME STUDY

CHART SV41: Ancestry of Chris SHILVOCK [Facebook]

Family tree back to the 1700's.

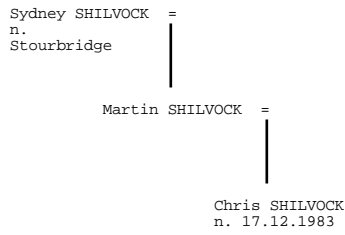
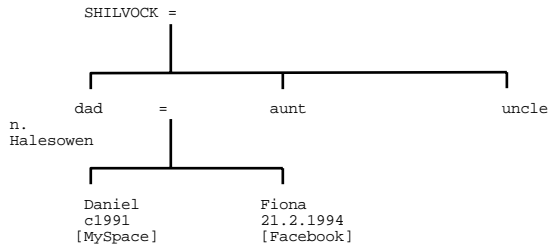

CHART SV42: Ancestry of Daniel & Fiona SHILVOCK [MySpace & Facebook]



Family in Manchester - originally from Halesowen.

SHILVOCK ONE NAME STUDY

Other SHILVOCK Data & Family Trees

Introductory Notes On Data Sources

International Genealogical Index 1992 (IGI)

All available counties have been searched. The following have no references -

Anglesey, Beds, Berks., Brecon, Bucks, Cambs., Carmarthen, Cornwall, Cumbria, Denbigh, Derbys, Devon, Dorset, Durham, Essex, Glamorgan, Hants, Herts., Hunts, IOM, Leics., Lincs., Oxon., Merioneth, Monmouth, Montgomery, Norfolk, Northants, Northumberland, Notts., Radnor, Rutland, Somerset, Suffolk, Sussex, Westmoreland, Wilts, Yorks., and unknown counties of England & Wales.

Minor number of references are found in (number):

Cheshire (1), Gloucs. (2), Hereford (1), Kent (1), Lancs. (2), Surrey (1),

Majority of references are found in (number):

Worcs. (186), Salop (118), Warks (66), Staffs (23), London & Middlesex (20)

Most of the following Worcs. IGI names are connected: SHILCOCK & SHILLCOCK (25 entries excluding CHILCOCK & SHELCOCK), SHILOCK, SHILIOK, SHILOCK, SHILOOCK (21 entries excluding CHILLIACK, SCHILICK, & SHELOCK).

Other Staffs IGI names which may be relevant: SHILOOK, SHILLOCK, SHILOOCKE (3 refs. total). Also SHILROCK under SHELICK (unknown number of refs.).

Other Salop IGI names which may be relevant: SHILOCK, SHELOCK.

Without exception all IGI refs. for Salop are SHELVOCK or variants - no SHILVOCK references at all.

Parish Registers

Halesowen: Period 1730-65, and 1826-1894 for christenings, 1831-1845 for burials, & 1861-1880 for marriages.
Northfield, WOR: 1814-21

Worcs. Wills

1800-1928 inclusive

Boyd's Marriage Index

London & Middlesex: 1538-1650 for both Brides & Grooms

2nd Series Miscellaneous:

Grooms: 1538-1725, 1751-1775 (1726-50 & 1775-1837 missing)

Brides: 1538-1700, 1751-1775 (1701-1750 & 1776-1837 missing)

3rd Series Miscellaneous:

Not examined.

1881 Census of England & Wales Index

1881 Census Index extracted for SHEL- & SHIL- for Warks & Worcs. detailing all known families. Contains surname variants! Census index indexed both according to Census District & Surname for ease of cross correlation.
Of other counties there were no refs. for Essex, Kent or Surrey. 1 reference for Middlesex.

St Catherine's House Indices

St Catherine's References are included and indicated by deduction/process of elimination or if known.
Births: to 1898 inclusive; Marriages: to 1890 inclusive; Deaths to 1905 inclusive

Deaths from 1866 also give age at time of death, which is a very useful tool for family connections (i.e. a guide to date of birth).

Note: Stourbridge RD includes Halesowen and many outlying villages towards Bromsgrove, Kidderminster & Birmingham.

Alphabetical Listing & Guide to Location of Town, Villages and Rural Districts

Alberbury = Salop
Aston JB = Warks (Juxta Birmingham)
Ashted = Warks
Baschurch = Salop
Belbroughton = Worcs.
Birmingham Churches:
BR = Bishops Ryder, St G = St George, St M = St Martin, St P = St Phillips, St PDE, St Peter (Dale End), St S = St Stephen
Borough = Halesowen Town
Brierley Hill = Staffs
Broadway = Worcs.
Broom = Worcs.
Caines = Worcs.
Cardeston = Salop
Chaddesley Corbett = Worcs.
Chetton = Salop
Clent = Worcs.
Cradley = Worcs.
Dodderhill = Worcs.
Droitwich = Worcs.
Dudley = Worcs.
Eccleshall = Staffs
Edgbaston = Warks
Ellesmere = Salop
Exhall = Warks, near Coventry
Fitz = Salop
Foleshill = Warks
Great Ness = Salop
Hagley = Worcs.
Halesowen = Worcs. St J the B = St John the Baptist
Handsworth = Staffs
Harvington = Worcs.
Hasbury = Halesowen
Hatton = Warks
Hawne = Halesowen
Holt = Worcs.
Islington = Halesowen
Kenilworth = Warks
Kingswinford = Staffs & Worcs.
Kinnerley = Salop
Lapal = Halesowen
Leamington Priors = Warks

SHILVOCK ONE NAME STUDY

Little Ness = Salop
 Llanymynech = Salop
 Montford = Salop
 Much Wenlock = Salop
 Old Swinford = Worcs.
 Oswestry = Salop
 Perry Barr = Warks
 Romsley = Worcs.; RSK = Romsley St Kenelms
 Rowley Regis = Staffs
 Ruyton of the Eleven Towns = Salop
 Short Cross = Halesowen
 Shrawardine = Salop
 Shrewsbury = Salop
 Smethcott = Salop
 Westbury = Salop
 Whittington = Salop
 Willenhall = Staffs
 Wolverhampton = Staffs
 Worthen = Salop

Abbreviations Used

Bg = Bromsgrove at St Catherine's
 c1768 = circa 1768
 c. = christening/baptism
 d. = death
 m. = marriage
 n. = birth (natus, to distinguish from b. which may indicate either birth or baptism)
 withn. = marriage witness
 + = burial
 < = before
 > = after

Other Data & Family Trees

Note: Family groupings are only suggestions based on information received by the author connectable to the same source or local area. Where no other candidates for relationships exist, these are inferred. Solid lines represent high probability of family ties, dashed lines are inferences. Question marks are suggestions only and need clarification through further research. Any suggestions for merging unconnected family groups or unattached individuals recognised from the list below are welcome.

Smaller Unattached Family Groups & Individual References to be Transferred to Trees Once Recognised

In alphabetical order

- A. SHILVOCK Private Royal Army Service Corps on St Mary's Oldswinford WWI Memorial
 Aaron Turner of Gosty Hill= Jane HALL; son Thomas c. 13.8.1820
 Albert SHILVOCK n. England d. Niagara Falls, Niagara, Ontario, Canada - Family: Ida Augusta JOHNS - no issue + Detroit, Wayne, MI d/o William JOHNS (of Cornwall) & Phidelia (of Dayton, Montgomery, OH)
 Alfred n. c10.1880 Old Swinford (3 months) and unmarried mother Ann (26), n. Kidderminster c1854, visiting Joseph MOULE in Kidderminster Borough, 1 Shakespeare Yard in 1881.
 Alfred Adolphe c. 2.12.1910 St J the B of Birmingham Road
 Alice Edith c. 28.8.1912 St J the B of 40 Birmingham Street (see also Walter Stanley)
 Ann = Benjamin LYNES 6.12.1824 Clent (probably sister of Thomas below).
 Ann of Hunnington bur. 15.8.1822 (76 - c1745)
 Ann of Hasbury (45) +11.3.1845 (n. c1800) Stourbridge Mar Qtr 18 403
 Ann SHILVOCK = Thomas SMITH 7.8.1836 Kingswinford
 Ann widow (76) n. Halesowen c1785, Seller of Sweetmeats, at 81 Peckingham St in 1861. Possibly the same Ann in 1851 at Birmingham Street, Halesowen, a Pauper widow (66) n. Halesowen with daughter Sarah PARTRIDGE (30), Nailor, and 2 grandsons William (9 n. Halesowen) & Charles (?17 - perhaps 7 n. Rowley, Staffs) both Nailors at Halesowen borough, East side Hagley St in 1841 aged 55, Y with Sarah SHILVOCK, 20, Y and unbaptised
 Ann 1851 census, Islington, Halesowen: 80, head, Pauper & nailmaker, in house next door to William & Mary SHILVOCK, with lodgers the BASTERFIELD family.
 Ann SHILVOCK, n. 1797 Head of family in Birmingham 1851 census (widow) at 44 Cottage Lane. Born Birmingham, at home with son James (n. 1838 Birmingham), son John (n. 1830 Mansfield, CHS [should be NTT]), daughter Mary Ann (n. 1836 Birmingham). Uncertain if a Salop SHILVOCK family or local SHILVOCK.
 Annie Elizabeth London Gazette 27th Jan 1942 #35435:Re ANNIE ELIZABETH SHILVOCK, Deceased. Pursuant to the Trustee Act, 1925. NOTICE is hereby given that all persons having a claim against the estate of Annie Elizabeth SHILVOCK late of Carlton Hotel Lord Street Southport Lancashire and formerly of 75 Pottery Road Warley Birmingham who died on the 13th day of November 1941 should give notice in writing thereof to us the Solicitors to the executors of the said deceased by the 3rd day of April 1942 after which date the assets of the said estate will be distributed having regard only to the claims of which notice has been received.-Dated this 21st day of January 1942. FOX, SAVILLE and WALKER, 15, Sunbridge Road, Bradford, Solicitors.
 Barbera = John WORLEY 22.5.1743 Halesowen St J the B, botp
 Barbara SHILVOCK: fosteredd by Floyd Wesley PARR & Georgina DAVIDSON m. 12.6.1926 London, Ontario. They had no children. Barbara SHILVOCK was living at Winnipeg, Manitoba in 1949 and later married Ken SHAW.
 Benjamin = Elizabeth STEVENS/STEPHENS 20.8.1746 Halesowen St J the B, botp

[N.B. Inconsistent dates for this tree - registers to check]

Benjamin SHILVOCK = Ann COOPER (at St P)
 m. 21.2.1783 St M

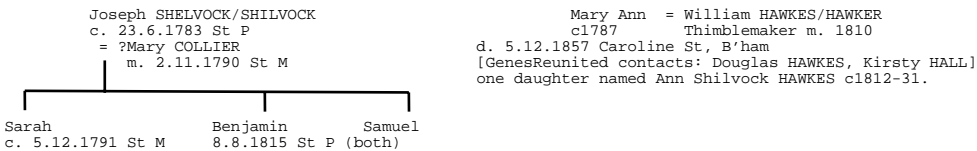

SHILVOCK ONE NAME STUDY

[N.B. Inconsistent dates for this tree - registers to check]
 Benjamin SHILVOCK/SHILVOCK = Ann MARTIN (at St M)
 m. 27.4.1812 St P

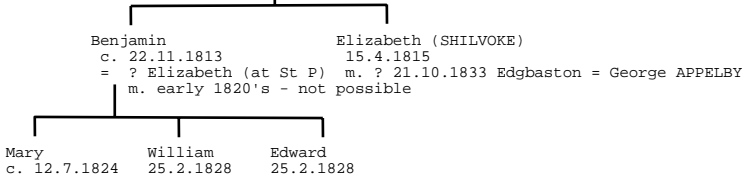

Bertha In the 1901 census is shown as a lodger, age 63 and married, at 152 Quarry Lane, Hasbury, Halesowen, in h/o William and Elizabeth CORBETT and 'Living on her own means'. Shown as 'feeble minded' so obviously not too well just 8 months before her death. Place of birth is shown as Birmingham, Warwickshire. Death notice in Birmingham Mail 26/11/1901: d/o late William PIPER, of Ladywood. Husband not mentioned.

Bryan La Corniche, Des Mouettes, 76980 Veules les Roses, Seine Maritime, France.

Charles infant of Hasbury, +19.1.1845 Stourbridge Mar Qtr 1845 18 399

1841: Halesowen, Peckingham St;
 Charles SHILVOCK, 30, Hawker, Y = Catherine, 20, Y
 (age probably rounded down from c25 years)
 m. <c1835
 Charles
 n. c1835

Charles = Mary (at Bloomfield St, Short Cross in 1885)
 Blacksmith (at Hawne Lane in 1891)
 m. Mar Qtr 1883 Dudley 6c 122
 at Hawne in 1901

```

    graph TD
      A[Charles = Mary (at Bloomfield St, Short Cross in 1885)  
Blacksmith (at Hawne Lane in 1891)  
m. Mar Qtr 1883 Dudley 6c 122  
at Hawne in 1901] --- B[Ethel May  
c. 25.1.1885  
Halesowen  
Button Polisher (1901)]
      A --- C[Florrie  
27.9.1891  
Sep Qtr 1891  
Stourbridge 6c 154  
c. 25.5.1892 Halesowen d/o ? SHILVOCK, Labourer of Great Cornbow, Halesowen  
ROYAL NAVY SHIPS IN PORT 1881 Census - John SHILVOCK U 26 M Birmingham A B (AB = Able Seaman) on  
"H M S Duke Of Wellington" at Portsmouth, Hampshire, England  
m. Dec Q 1923 Stourbridge  
= HACKETT]
    
```

(Note: Only Ethel May (as SHILVOCK) at Aston Sep Qtr 1892 6d 387)

Christopher Dead Canaries found in car at Henley-In-Arden Market man fined (16/10/2000); "A Stourbridge man has been fined £100.00 with £250.00 costs after two canaries he left in the back of a vehicle died of heat exhaustion. Christopher SHILVOCK pleaded guilty to two offences under the Protection of Animals Act 1911, at Stratford Magistrates Court on Friday 13th October (2000), following a prosecution by Warwickshire County Council's Trading Standards Service."

D Knorr E., Ng R., SHILVOCK D., "Finding Boundary Shape Matching Relationships in Spatial Data", Proc. 5th Symp. On Spatial Databases (SSD'97), S. 29-46, 1997

Dane G B Drummer with Birmingham managed band "Mugwump" (1997) on WWW. Mark SHILVOCK plays bass & vocals.

David ROYAL NAVY SHIPS IN PORT 1881 Census - John SHILVOCK U 26 M Birmingham A B (AB = Able Seaman) on "H M S Duke Of Wellington" at Portsmouth, Hampshire, England

Diana = William GANDERTON 12.5.1805 St M

E London Gazette #30873 of 26th August 1918: His Majesty the KING has been graciously pleased to approve of the award of the Military Medal for bravery in the Field to the undermentioned Non-commissioned Officers and Men: - 16056 L./C. E. SHILVOCK, E. War. E. (Leamington)

Edward at 30 Holy Cross in 1861, servant, 14, WOR Clent in household of Joseph CUTLER, horse dealer

Edward aged 5, at 54 Islington, boarder, scholar, of Halesowen in household of Charles RUDGE

[possible second marriage of s/o Isaac & Maria?]
 Edward = Sarah (Islington in 1889)
 Rivet Maker

```

    graph TD
      A[Edward = Sarah (Islington in 1889)  
Rivet Maker] --- B[m. ?Stourbridge Mar 1887 6c 153]
      B --- C[Sydney  
n. 18.3.1888  
c. 6.3.1889  
m. Mar Q 1913 Dudley = Elizabeth LLOYD  
4.11.1881-23.7.1973  
m. 8.3.1913]
      C --- D[d. 22.12.1963]
      D --- E[children: Elizabeth SHILVOCK  
n. 4.3.1914 Stourbridge - 1.9.1962  
m. 20.7.1940 = John Harry PRICE]
    
```

[jeffrey.ratcliffe(at)t-online.de]
 [GenesReunited contact: Richard PRICE]

Edwin SHILVOCK, 30, Nailor, Y = Phoebe SHILVOCK, 28, -----, Y (in 1841 Halesowen)
 (Phoebe probably 40 year old widow in 1851 below)

Ellen witness to m. 3.4.1870 Halesowen of Ben MOSES = Sara Ann HUTTON
 Ellen (47) married (by c1853), head (not given as widow) in 1881, Spring Hill Hasbury, with Mary Ann (7 - 1873, Aston Q4 6d 383) & Fanny (4 - 1876, Aston Q2 6d 417). All n. B'ham. Ellen formerly ASHTON? Possible marriage Aston 1871 Q3 6d 494 between Ellen ASHTON (c1834, B'ham) unmm. Warehouse Woman in 1871 at 1 Back 243 Farm St., B'ham St George & Thomas c1837 unmm. gun barrel borer in 1871 with father William (c1798, both of Hasbury) at Wellington Square, Handsworth. Thomas is married by 1881 as SHILROCK at 17 Aston Lane with his sister Mary Ann's family.
 = Thomas CRUMPTON 26.12.1870 Old Swinford - 6c 247 Stourbridge Dec Qtr
 w/o John of Warly Wigorn bur. 30.7.1730 St J the B, Halesowen (John perhaps bur. in 1748?)
 Eliza d/o Joseph (24, n. c1853)= William MANN (23) s/o Joseph 21.1.1878 Clent
 Eliza aged 3 of Clent d. buried 2.11.1822 at Clent (may be s/o Charles & Elizabeth of Clent)
 Elizabeth widow bur. 26.12.1738 Halesowen, St J the B
 Elizabeth of Romsley bur. 17.6.1740 St J the B
 Elizabeth bur. 23.4.1764 St J the B
 Elizabeth bur. 11.9.1698 St J the B
 Elizabeth SHILVOCK = Henry BEARE 18.11.1694 St Katherine by The Tower, London
 Elizabeth SHILOOCK (18 n. c1863 Hagley), Servant at the home of Joseph SMITH in Redditch 1881
 Elizabeth House Servant, U, 25 born STS, Wordsley in household of Rowland PRICE, solicitor
 Elizabeth Stourbridge, Upper High St., 1851 census
 Elizabeth Lodger, U, Factory girl, City of London, in household of Phebe THRIP, 024 Holy Cross, Clent 1851 census
 Eleanor SHILVOCK = Ralph SUMMERFIELD 10.8.1735 Mitcham, Surrey
 Emily SHILVOCH, 43 n. c1837 Liverpool, widow, at h/o Charles HUGHES, Aston in 1881 (given as m-in-law to Head)
 Ethel Maudc. 23.8.1911 St J the B of Blackberry Lane

SHILVOCK ONE NAME STUDY

F. SHILVOCK Sergeant Royal Warwickshire Regiment on St Mary's Oldswindford WWI Memorial
 F. SHILVOCK Sapper Royal Engineers on St Mary's Oldswindford WWI Memorial
 Florence Beatrice c. 28.9.1893 St J the B
 Florrie c. 25.5.1893 St J the B of Great Cornbow; probably of Stourbridge Road & m. Allan TAYLOR of Cherry St 18.1.1911 at St J the B
 Francis SHELVOCKE = Eleanor RANSOM 17.10.1728 Westminster St Clement Danes
 Frederick n. c1877 d. 21.11.1917 (40) (WWI) = Clara J. (later remarried to HILL of 220, Rood End Rd., Oldbury [m. Dec Q 1921 W Brom.])
 Frederick James Fred & Clara in Hasbury in 1901.
 s/o Frederick James 26, Lyng Lane, West Bromwich; husband of Eliza SHILVOCK, of 32 Back, Queen St., Kidderminster d. 6.9.1917 (WWI).aged 32. (n. c1885)

G. SHILVOCK Private Oxford and Bucks Light Infantry on St Mary's Oldswindford WWI Memorial
 George Mrs SHELVOCKE n. c1701 London
 George "Capt." SHELVOCKE n. c1700, London, perhaps s/o the famous Capt. born 1675 of Salopian family in Deptford.
 George SHELVOCKE = Mary JACKSON 26.5.1758 Greenwich, Kent
 George SHELVOCK = Judi LOVELACE 1817 at "Bp London" (Boyd's MI)
 George = Ann GROVE 27.4.1811 St P
 George of Borough bur, 20.5.1821 (7)
 George at 10 Pedmore Lock, Halesowen in 1861, Apprentice to Thomas TOMPKINS (Master Blacksmith & Wheelwright) U, 16, WOR, Clent
 George Nailor, 60, Y = Ann, 60, Y (1841 Halesowen census) - perhaps above couple?

H. SHILVOCK Private Royal Warwickshire Regiment on St Mary's Oldswindford WWI Memorial
 H. SHILVOCK Corporal on Stourbridge War Memorial of 1923
 Hannah = Benjamin DENTON 14.8.1790 Aston JB
 Hannah both as SHILWORK & SHILVOCK (on IGI) = Edward WRIGHT 20.5.1730 Dudley
 Hannah w/o William of Ramsley (Romsley) bur. St J the B, Halesowen 11.3.1736 (poss. m/o Hannah below)
 Hannah SHELVOCKE = Joseph HARRIS 24.9.1804 Cradley Chapel, botp, both made mark
 Hannah = John THOMAS 25.12.1820 Halesowen
 Hannah SHELLVOCK = Matthew John GIBBONS 4.4.1785 Westminster, St Martin in The Field

J. SHILVOCK Private Worcestershire Regiment on St Mary's Oldswindford WWI Memorial

James = Caroline (at Birmingham St S)
 n. pre GR
 m. ?Sep Qtr 1872 Stourbridge 6c 260 (as SHELVOCK)
 Ada Mary Florence Annie
 n. N/F N/F (perhaps as SHELVOCKE)
 c1869 Birmingham
 c. 6.7.1873 6.7.1873
 (Florence A (11), is a pupil at The Blind Institution, Carpenter Rd, Edgbaston in 1881)
 (Ada in Stratford, London in 1901, forewoman in Box Maker Factory)

James = Rhoda (at Lower Hagley in 1881)
 (30) (30)
 n. c1851 c1851
 Hagley Gornal, Staffs
 Bromsgrove Signalman m. ?Stourbridge Sep Qtr 1872 6c 260 (as SHELVOCK)
 Helen Winifred Beatrice
 (2) (3 months)
 n. c1879 c1881
 Hagley
 = NOBLE
 m. Jun Q 1912
 Bromsgrove

James c. 20.9.1914 St J the B of 16 Little Cornbow
 Jane SHELVOCKE = William TURNER 14.9.1712 St Katherine by The Tower, London
 Jane Head, W, 53, Shop keeper, WOR Chaddesley Corbett at 025 Clent, Bromsgrove, 1851 census
 Joan SHILBURN or SHILVOCK (See John, below).
 John SHELVOCKE = Anne ROBINSON 20.1.1668 St James Clerkenwell
 John SHELVOCK = Mary APERLIE/APPERLEY 24.6.1684 St James Duke Place, London
 John = Mary CROSSWELL or CROSWELL 6.12.1730 St J the B, Halesowen botp
 John of Hasbury (3) +3.1.1837 Halesowen (n. c1833)
 John of Borough (20) + 16.6.1833 (n. c1812)
 John d. 20.12.1830 (Infant of B'ham)
 John = Sarah HARRIS 21.11.1830 Dudley
 John SHILOOCK = Mary JONES 30.8.1846 Halesowen [DIXON?] Sep Qtr 1846 Stourbridge 18 496 (same ref. as William)
 John SHELVOCKE = Anne EDKINS 8.5.1615 Worcester, St Michael Bedwardine
 John SHELLVOCKE = Margaret BUTLER 2.11.1616 Worcester, St Michael Bedwardine
 John = Margaret GORE 25.12.1773 Manchester Cathedral (one of two Lancs. refs.)
 John = Martha SHELVOCK 18.2.1776 Liverpool St Peter (one of two Lancs. refs.)
 John = Eleanor B WALFORD 14.12.1858 St M - Dec Qtr 1858 B'ham 6d 157
 John of Halesowen - Will 30.9.1803 Admons at Worcester (to be extracted)
 John of Halesowen - Will Aug 1919 (p.345)
 John a SHILVOCK c. 12.1830 & d. 26.12.1830 at Clent
 John of Clent - Will 22.9.1836 at Worcester (to be extracted)
 John of Droitwich - Will July 1873 (p393) - Mar Qtr 1873 Droitwich 6c 255 aged 67 n. c1805
 John of Warly Wigorn see wife Eliza, bur. 1730
 John of Worly Wigorn bur. 1.2.1746/47 Halesowen St J the B (perhaps his wife Eliza bur. in 1730?)
 John or Joan SHILBURN otherwise SHILVOCK bur. 20.2.1761 St J the B *
 *(also recorded as Joan by some researchers - the alias name of SHILBURN is believed to be a name possibly due to adoption i.e. stepchild situation. It is also sometimes used in 'common law marriages').
 John SHILVOUCK, 51 n. c1829 B'ham, as Head, widower, Aston in 1881
 John = Mary Ann on 1900 (not 1910) census in San Jose, California. He n. c1844, She n. c1849. Married c1891, but both n. England. He emigrated in 1889. Children: John Jr. (8.1892) & August S. (5.1895).

John SHELVOCK = Sarah (sole Cheshire ref. - probably Salop connections)

Martha
 c. 21.4.1771 Chester, St John the Baptist

John = Mary BURGESS
 m. 25.12.1865 Hatton - Dec Qtr 1865 Warwick 6d 803

John
 c. 25.11.1866 Coventry HT
 n. Dec Qtr 1866 Coventry 6d 433

John = Eliza Ann POOLE

SHILVOCK ONE NAME STUDY

m. 5.8.1860 Kenilworth - Sep Qtr 1860 Warwick 6d 609

Caroline SHELVOKE
c. 10.2.1862 St M
n. ref. N/F

John Paul Co-author of many papers on sugars.
John SHILVOCK-WRIGHT: London Gazette #30310 25th September 1917: SPECIAL RESERVE OF OFFICERS. The undermentioned, from Officer. Cadet Units, to be 2nd Lts.:-John SHILVOCK Wright, 2nd Sept. 1917.
Joseph d. 4.7.1917 (26) in WWI. Husband of Edith SHILVOCK formerly BARTON, of 21, Hill St., Halesowen. Married Q1 1916.
Joseph + 24.7.1763 St J the B
Joseph = Sarah OWEN 7.7.1787 St M
Joseph aged 17, Nailmaker, lodger in household of George WILLETS (also lodger Joel HALL, spademaker U, 20, WH) 221 New St, Hasbury, in 1861.
Joseph (n. Halesowen c1843; possibly Dec Qtr 1842 Stourbridge 18 416 - ?parents)
Joseph of Halesowen - Will 26.1.1824 Admons at Worcester (to be extracted)
Joseph = Sarah GAUNT 11.8.1764 Clent (Joseph possibly of RSK origins)
Joseph d. or buried 8.3.1807 at Clent (perhaps Jo above?)

Joseph = Hannah (of Warley Wigorn)
bur. 23.6.1730 & 29.11.1758 at Halesowen, St J the B, respectively
[no known issue]

Joseph = Mary

William SHILROCK
c. 3.12.1760 Halesowen, St J the B

Joseph SHILVACK (33) n. c1847 Harbury, WOR Chaser (Artz)	=	Mary (at Victoria Road 5 Bexwell Place 175, Aston in 1881 on 1341727/343/70/p. 41) (30) ?STEVENS c1850 B'ham m. <1870					
<table border="0" style="width: 100%; text-align: center;"> <tr> <td style="width: 20%;">Florence ?Stevens (10) n. c1870 All Aston</td> <td style="width: 20%;">Arthur (8) c1872</td> <td style="width: 20%;">Emily Mary (6) c1874</td> <td style="width: 20%;">Frederick (4) c1876</td> <td style="width: 20%;">Lillian (1) c1879</td> </tr> </table>			Florence ?Stevens (10) n. c1870 All Aston	Arthur (8) c1872	Emily Mary (6) c1874	Frederick (4) c1876	Lillian (1) c1879
Florence ?Stevens (10) n. c1870 All Aston	Arthur (8) c1872	Emily Mary (6) c1874	Frederick (4) c1876	Lillian (1) c1879			

JW Patent GB482212: Magazine firearms. BIRMINGHAM SMALL ARMS CO., Ltd., SHEPHERD, R. V., and SHILVOCK, J. W. Sept. 25, 1936, No. 26020. [Classes 9 (i) and 92 (ii)] A magazine and magazine-charging device for a machine gun or other magazine firearm comprises a curvilinear box 4 constituting the magazine and a charger 1 of similar curvilinear form which slides within the magazine to load the cartridges thereinto and is then withdrawn, the cartridges being retained in the magazine by a spring-pressed catch 7. The charger has arms 1 to receive the rim and bullet ends of the cartridges, the arms having spring tongues 5 at their ends to prevent displacement of the cartridges, which are held in the same staggered relation in the charger which they are required to occupy in the magazine. Gaps 2 between the arms allow ribs 11, Fig. 2, on the inside of the magazine to support the sides of the cartridges when the charger is slid into the magazine, the spring catch 7 wiping over the sides of the cartridges during their introduction into the magazine. When the magazine is loaded, the charger is withdrawn by the handle 12 and the catch 7 then prevents the cartridges from falling out of the magazine. The magazine has a hook 13, and a projection 14 which is engaged by a catch to retain the magazine in position on the receiver 9 of the firearm, when the magazine has been loaded, the positioning of the loaded magazine on the receiver causing a projection 10 on the receiver to engage the catch 7 and thereby release the cartridges for supply to the receiver under the action of the magazine follower.

Katherine SHULVOCK = Joseph PLOMLEY 12.9.1727 Yate (one of two Yate refs. for sole Gloucestershire refs.)

Leah of Hasbury (7 weeks) +2.12.1844 Halesowen - Dec Qtr Stourbridge 18 358
Leonard d. 10.8.1915 (WWI in Egypt). Age 21 (n. c1894). Son of Mrs. Sarah SHILVOCK, of 12, Islington, Halesowen. In Halesowen in 1901 census.

Lillian c. 29.11.1911 St J the B of Birmingham Street
Lilly Elizabeth c. 9.7.1871 Droitwich St Andrews d/o of William and Mary Ann SHILVOCK, of St Nicholas, Clerk.
m. Aylesbury, in the District of Aylesbury in the County of Buckingham, 28.5.1890
= Albert Henry BROOKS (20), Bachelor; Electrotyper; of Silver Street, Aylesbury, s/o Joel, Bootmaker
Lily Elizabeth (sic) (19) years, Spinster; of Buckingham Road; d/o William, General Clerk
Witnesses: Frances Alfred COWLEY and Rose BROOKS.
Family story [Ted HANLON] is that Lily was pregnant at the time of the marriage; a bad marriage since Albert was a heavy drinker but produced 9 children. The rest of the SHILVOCK family is said to have moved to Johannesburg, South Africa shortly after the marriage leaving Lily behind. It is said that they were involved in a shoe factory in Johannesburg and did send her the fare for the crossing, but she never left.

Lucy (13) n. c1868 Hagley (not d/o Joseph & Sarah), Visitor at Eliza BLAKE, Redditch in 1881
Lucy of Borough +7.11.1824 (58) at Halesowen (n. c1766)

Mark band member of "Mugwump" in 1997 - see Dane, above. (poss. married to Mandy and living L. Gornal in 2007)
Martha = John SHELVOCK 18.2.1776 Liverpool St Peter (one of two Lancs. refs.)
Martha 25, n. c1855 Halesowen, Servant at h/o Arthur E. FIELD, Aston in 1881
Mary = Joseph WATSON 30.5.1871 Dudley St Thomas - Jun Qtr 1871 Dudley 6c 117
Mary SHELVOCK = John HOOPER 7.4.1724 Yate (one of two Yate refs. for sole Gloucs. refs.)
Mary SHELVOCK = Samuel RAINSLY 30.3.1823 Coventry HT
Mary sp = George FIELD 17.7.1814 Northfield (wit. Joseph ROSE & Thomas WITHERS)
Mary = Robert DOUGLASS 15.3.1814 St M
Mary = Joseph UNITT 10.8.1806 St M
Mary SHELVOKE = Edward WRIGHT 2.5.1872 Leamington Priors/Jun Qtr 1872 Warwick 6d 720 (SHILVOCK-WRIGHTS?)
Mary SHELVOCK = John ARKINSTALL 1700 at "Fac. Off." (Boyd's MI)
Mary SHELVOCK = James BLACKDON 21.2.1710 St Martin in The Field, London
Mary = Jos BURTON 1.1.1732 St John the Baptist, Halesowen botp
Mary d. or buried 5.5.1803 at Clent (a wife or child?)
Mary SHELVOCK = James Lewis BIDDULPH 25.4.1831 St M
Mary SHILOOCK = John LANE 18.5.1847 Halesowen - Jun Qtr 1847 Stourbridge 18 610
Mary SHILVOLK: 3xGGF of Douglas HAWKES - Mary Ann = William HAWKES (HAWKER on IGI) on 13.8.1810 in Aston Juxta Birmingham. William on census reports from 1841 to 1871 and in many directories (silver thimble maker, silversmith). He is probably the William ch 30 Mar 1789 in Saint Phillips, parents Thomas Hawkes and Elizabeth.
Matilda 1901 m. in Halesowen = Frank Henry (Harry) RUDGE
Matthew "BRICK ATTACK MAN IS SPARED JAIL SENTENCE" - Express & Star Thursday, February 12, 2004
A Black Country man who hurled a house brick at a man's head during a dispute between neighbours has escaped a stint behind bars. Trouble erupted when Matthew SHILVOCK pushed a young boy playing on a Cradley estate last July, said Mr. Philip Bradley, prosecuting at Wolverhampton Crown Court. The boy's father, Roger Francis, went to confront him about it, but 19-year-old SHILVOCK, who was with a man named Dean Cappella, struck him with a house brick, said Mr. Bradley. "But this was not the end of it. Mr. Francis lost his balance and fell to the floor. He was then set about by both men" he added. Mr. Francis received a cut to the head which required five stitches. SHILVOCK of Highfield Crescent, Cradley admitted wounding and was given 100 hours community punishment, an 18 month community rehabilitation order and told to pay Mr. Francis £300 compensation.....Mr. Graeme Simpson defending SHILVOCK admitted his client pelted the victim with a brick and kicked him in the body while on the ground. "Good character saves stone throwing man from jail sentence"
From the archive, first published Thursday 12th Feb 2004.
A brick-hurling Cradley teenager walked free from court this week after admitting his part in a Highfield Crescent ruckus.

SHILVOCK ONE NAME STUDY

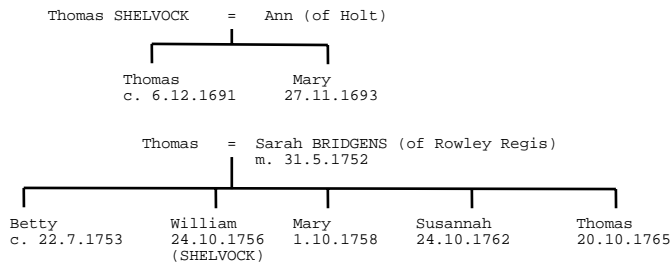

W. SHILVOCK Private Royal Army Service Corps on St Mary's Oldswindford WWI Memorial
 Walter Stanley c. 10.6.1914 St J the B of 40 Birmingham Street (See also Alice Edith)
 William SHELVOCK = Hannah COOKES 4.2.1702 Chaddesley Corbett (researcher believed daughter Hannah m. John GRIFFIN 1730-91 and d. 19.2.1794; however Hannah GRIFFIN identified on John SHILVOCK's 1770 will as his daughter on Chart 13A)
 William of (Halesowen) Town bur. 3.6.1730 St J the B, Halesowen
 William lodger at Islington (73), in 1871, Nailmaker, widower (n. c1798). Possibly head of [MILES] tree and/or s/o Joseph & Sarah, or Samuel & Sarah. Late wife probably Mary alive in 1861)
 William Slater's 1852/53 Directory of Birmingham; gun barrel borer, Phillip Street, Aston Brook. Not in the street during time of 1851 census.

William SHILLCOCK = Emily
 |
 Alfred
 c. 14.6.1869 Cradley
 not 1866 ref.

William SHILVOAK = Mary (living at Moor Street, Northfield in 1821)
 |
 Nailer Sarah
 c. 26.10.1821
 St Laurence, Northfield

William = Sarah (at St S)
 |
 Florence
 c. 31.3.1867

William = Margaret CARLESS 31.12.1744 Halesowen St J the B
 William s/o Sarah, Islington Nailer c. 31.12.1838
 William = Mary CURTLER 22.8.1731 St J the B, Halesowen, botp
 William of Town bur. 8.11.1734 St J the B, Halesowen (either husband of Mary or a child)
 William SHILVOCK, witness to marriage of Edward SMITH widower, of this parish and Mary CARTWRIGHT of Halesowen spinster, 21 years and upwards, on 1st March 1836 at Broom, Clent.
 William Edward SHILVOCK-WRIGHT PRO ref:WO/339/13809.
 n. 17.2.1900 Solihull. Served with BEF in France Dec 1915 - Aug 1916, transferred to RFA - served as Gunner 102347, 16/8/1916 - 6/9/1916 - discharged under age; mis-statement on enlistment. Gassed in Loos 1916. Not clear when he re joined, but accepted for Officer training from 12/8/18, appointed temporary second Lieut. RFA 3/4/1919. London Gazette #31298 of 15th April 1919.
 There is a letter asking for his prompt release on compassionate grounds as his brother, JS WRIGHT was killed in action, 7/11/1918, and his widowed mother needed him home to run the family business in Dale End Birmingham. Father died 1911. Occ in Civil life - builder and contractor, Quantity Surveyor
 William Henry Note: Lillian M SHILVOCK-WRIGHT = HARRISON Jun Q 1925 Solihull
 London Gazette #37144: 22nd June 1945 -
 William Henry SHILVOCK, M.B. As Serving Brother.
 THE GRAND PRIORY IN THE BRITISH REALM OF THE VENERABLE ORDER OF THE HOSPITAL OF ST. JOHN OF JERUSALEM.
 Chancery of the Order,
 St. John's 'Gate,
 Clerkenwell, London, E.C.I.
 22nd June, 1945.
 The KING has been graciously pleased to sanction the following Promotions in, and Appointments to, the Venerable Order
 Is this the WH SHILVOCK - artist?

William Henry "Three Cases of Nasal Sinus Disease": Kathleen A. H. Sykes and William Henry Shilvoock
 Journal of Mental Science 1931 77: 185-192.